

60 cents

hrc

focus
on
communications
technology . . .

ham radio

JULY 1968



40m

20m

15m

10m

bandswitching
FET
converter

this month

- solid-state vfo transmitter for ten 10
- low-noise 144-mhz fet converter 14
- one-transistor rig for forty 44
- simple multi-band antennas 54
- high-frequency transverter 68



ALL NEW
THE TRI-EX
FREESTANDING
sky
needle
TM 370

*Holds 30 sq. ft. of
antenna in 60 mph wind.*

Telescopes to 70 feet up

Nested at 27-ft., it can be quickly run up to its full 70-ft. for instant use. The TM 370 Sky Needle is the only Tri-Ex telescoping tubular mast specifically designed for amateur antennas. Absolutely freestanding, the TM 370 will support a full 30 sq. ft. of antenna in a 60 mph wind. Only the best high-strength steel, welded by certified welders, is used in the tower's construction. Each section is fully galvanized—inside and out—after

fabrication for all-weather use. Single crank up and down operation is assured by the extra heavy-duty worm-gear, self-locking safety winch and galvanized aircraft-type cable. No special crane is needed to erect the Sky Needle because of its tilting hinged base. A ladder and work-platform is available as accessories. Tri-Ex offers immediate delivery. No shipping charges inside continental U.S.A. Write now for free brochure.

**Tri-Ex TOWER CORPORATION**

7182 RASMUSSEN AVE., VISALIA, CALIF. 93277



When hams
discuss
**OPTIMUM
SPACING'**
in single
band beams . . .

..... *The subject turns to **Mosley***

Amateurs punch through the ORM on 20 meters with Mosley's A-203-C, an optimum spaced 20 meter antenna designed for full power. The outstanding, maximum gain performance excels most four to six element arrays. This clean-line rugged beam incorporates a special type of element design that virtually eliminates element flutter and boom vibration. Wide spaced; gamma matched for 52 ohm line with a boom length of 24 feet and elements of 37 feet. Turning radius is 22 feet. Assembled weight - 40 lbs.



20
meters

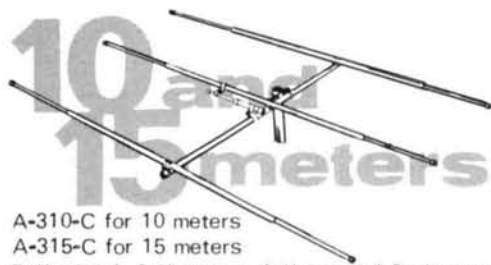

A-310-C for 10 meters
A-315-C for 15 meters

Full sized, full power, full spaced 3-element arrays. 100% rustproof all stainless steel hardware; low SWR over entire bandwidth; Max. Gain; Gamma matched for 52 ohm line.

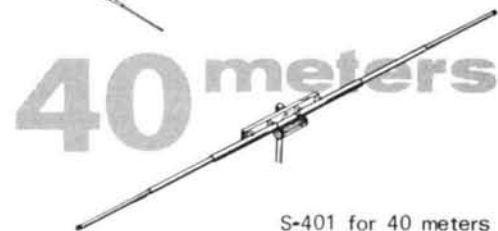

S-401 for 40 meters

Full powered rotary dipole. Top signal for DX performance. 100% rustproof hardware. Low SWR. Heavy duty construction. Link coupling results in excellent match. Length is 43' 5 3/8"; Assembled weight - 25 lbs.

For detailed specifications and performance data, write Dept 157.

Mosley Electronics, Inc. 4610 N. Lindbergh Blvd., Bridgeton, Mo. 63042



Some comments from warranty cards by owners of

DRAKE TR-4 SIDEBAND TRANSCEIVERS



"The TR-4 is the best rig I have ever known to be made. Glad to own one."

Dan Tangorra, WA7FWH
Tacoma, Wash.

"Finally got what I wanted!"

Ronald E. Lyons, WB2BQX
Oakhurst, N. J.

"A superb piece of equipment, no comments necessary."

C. G. Noakes, G3UHR/V02
Labrador City, Newfoundland

"Great rig—First contact was an ONS in Belgium."

Bill Busse, WA9TUM
Mt. Prospect, Ill.

"Best gear I have had the pleasure of working with. Receiver is exceptionally sharp and stable."

Albert V. Mitchell, WA9BUP
Jeffersonville, Ind.

"Nothing to comment, except that my TR-4 is a real jewel, and I am very satisfied with it. I would like to receive the catalogue of your products."

Joe Braz Ribeiro, PY4UK
Monte Carmelo (MG) Brazil

"A very F.B. piece of equipment. Audio very nice, especially on SSB, which is rare."

Thomas F. Totten, Jr. WB2GZR
Saratoga Springs, N. Y.



"Running it with a Mosley 'Classic' beam and proves a most fine and nice transceiver. Really proud of it."

Orlando Escudero O., CE-3-0E
Santiago, Chile

"Looks good—sounds good—very well pleased with performance."

Wayne M. Sorenson, WA0ETL
St. Paul, Minn.

"Have had Drake 2-B for three years. Knew that TR-4 was same Good Stuff."

Charles E. Bishop, WA8FTT
Columbus, Ohio

"Just what I always wanted."

Daniel N. Hamilton, WA4WXQ
Ashland, Va.

"Why not build a good 6 Meter SSB & AM Transceiver . . . hurry up, I'm waiting."

Harold A. Zick, WA9IPZ
Creve Coeur, Ill.

"Excellent equipment."

W. T. Newell, WB6UZU
Palm Springs, Calif.

"O.K. 100 x 100. RV-4: O.K./W-4: O.K./L-4: O.K. Very Good!"

Francisco Fau Campmany, TI-2-FAU
San Jose de Costa Rica

"A beautiful piece of equipment. My second piece of Drake. The first was a 2-B and this sold one friend an R-4 receiver and another a TR-4. We are Drake-minded here in town. Many thanks."

Charles E. Boschen Jr., WA4WXR
Ashland, Va.

"I'm sure this, like the other Drake equipment I have, is the finest money can buy. YOU MAY QUOTE ME ON THAT."

C. E. (Ed) Duncan, WA4BRU
Greenville, S. C.

"I'm a real happy man with it. Does a real good job of getting thru."

Jerome D. Lasher, W2RHL
Hamburg, N. Y.

"Replaces my TR-3."

D. G. Reekie, VE 6 AFS
Calgary Alberta Canada

"Finest performing gear I have ever had the pleasure of operating."

Milton C. Carter, W2TRF
Lakewood, N. J.

"PS Several months have passed . . . I now employ TR-4 as mobile unit and base station. I have logged more than 1000 contacts, many being rare DX. I am looking forward to owning a second unit to be used strictly for mobile. To date TR-4 has been trouble-free."

Milton C. Carter, W2TRF
Lakewood, N. J.

"Well pleased."

Rev. James Mohn, W3CKD
Lititz, Pa.

"I am delighted with Drake gear. This is the second of your transceivers for me. I have used a TR-3 in my car for about 2½ years—only trouble: replacing a fuse!"

Guy N. Woods, WA4KCN
Memphis, Tenn.

"Ask the ham who owns a Drake TR-4"

... or write for details ...

Dept. 458 **R. L. DRAKE COMPANY** 540 Richard St., Miamisburg, Ohio 45342

july 1968

volume 1, number 5



ham radio

staff

editor

James R. Fisk,
W1DTY

roving editor

Forest H. Belt

vhf editor

Robert M. Brown,
K2ZSQ/W9HBF

associate editors

A. Norman Into, Jr.,
W1CCZ/K2IEO
Nicholas D. Skeer,
K1PSR
James A. Harvey
WA6IAK

art director

Jean Frey

publisher

T. H. Tenney, Jr.,
W1NLB

offices

Greenville, New Hampshire 03048
Telephone: 603-878-1441

ham radio is published monthly by Communications Technology, Inc., Greenville, New Hampshire 03048. Subscription rates: U.S.A. and Canada, one year, \$5.00, three years, \$10.00. Copyright 1968 © by Communications Technology, Inc. Title registered at U.S. Patent Office. Printed in Montpelier, Vermont 05602, U.S.A.
Postmaster: Please send form 3579 to ham radio, Greenville, New Hampshire 03048.

contents

Bandswitching FET Converter Michael J. Goldstein, VE3GFN	6
Solid-State VFO Transmitter for Ten Meters Robert M. Brown, K2ZSQ	10
Transistorized 455-kHz BFO E. H. Marriner, W6BLZ	12
Low-Noise 144-MHz FET Converter Robert J. Kolb, WA6SXC	14
Phase-Shift SSB Generators Forest H. Belt	20
Instrumentation and the Ham Michael J. Goldstein, VE3GFN	28
Which Way does Current Flow? James Ashe, W2DXH	34
Choosing Diodes for High-Voltage Power Supplies E. H. Marriner, W6BLZ	38
Dual-Channel Compressor John J. Schultz, W2EEY	40
One-Transistor Rig for Forty Meters E. H. Marriner, W6BLZ	44
Handy Transistor Tester James M. Lomasney, WA6NIL	48
Simple One-, Two- and Three-Band Antennas Herbert S. Brier, W9EGQ	54
Transistor Voltmeter, Part II R. S. Maddever	60
Troubleshooting Transistor Ham Gear Lawrence Allen	64
High-Frequency Transverter John Stanley, K4ERO	68
RTTY Adapter for the SB-300 Maurice E. Cox, W2ARZ	76
departments	
A Second Look	4
Advertisers Index	96
Ham Notebook	74
New Products	86
Propagation	80
Repair Bench	64

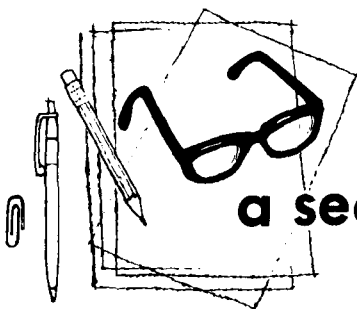

a second look

by jim
fisk

I have been appalled by the number of bad operating practices that have been cropping up on our bands during the past few months. Evidently other people have been troubled too, because I have received several letters on the subject. None of these practices is new, they're just more prevalent. Deliberate interference, tuning up on net frequencies, playing music, calling CQ without listening first, obscene language, incorrect identification or no identification at all, using a kilowatt when 100 watts will do, talking cross-town on 20 meters instead of using vhf—the list could go on and on.

Our high-frequency bands are crowded, but deliberate and malicious interference, and discourteous operating tactics aren't going to relieve the situation. Everything is more crowded today; the population has exploded, the expressways and turnpikes are jammed, homes are being built on smaller and smaller pieces of land, and practically everywhere you go, you find a mass of humanity. It follows that we'll have congestion on the amateur bands—but congestion doesn't necessarily mean bedlam. Zeroing your kilowatt in on a QSO or local net isn't going to make them move. Why not join them? They'd

probably be glad to have you.

Today, there is a net for almost every range of interest—they aren't restricted to handling traffic. Some of the groups that congregate on the bands are not really nets at all, but simply groups of hams who get together for a common purpose. There are DX nets, such as the International SSB'ers (who also handle traffic), the county hunters, the Cracker Barrel and Breakfast Club nets on 75 meters in the morning and various single-frequency gabfests. There are technical nets and the VHF Nut Net, for the vhf addicts, and of course, a multitude of local and intercontinental traffic nets, if traffic handling is your forte.

If you don't like net-type operation, fine; there are many amateurs who don't. On the other hand, if there weren't any nets, just imagine what the QRM would be like. There are thousands of amateurs who congregate on particular net frequencies; since they're a member of a net, they just "read the mail" a good deal of the time. If they didn't have the net, they would be calling CQ, fishing for a new county or active in one of the horrendous DX pileups. So, when you hear a net in operation, don't use it for a tuneup frequen-

cy. Whether you know it or not, the most hedonistic of them will stand by to handle traffic if asked to do so. They **all** do a service to the amateur fraternity by minimizing interference with channelized communications.

Six months ago, the FCC legalized "tail-ending." This is a big boon to the traffic handlers and the DX and contest operators because it allows them to transmit only their own callsign when calling another station. It also minimizes QRM because it lessens the amount of information that has to be transmitted. However, even with legalized tail-ending, you must still send both your call and the call of the station you are working at the **end** of the exchange.

The law is very explicit in this respect. Although you can send only your own call at the beginning of an exchange, or at intervals not greater than ten minutes, you must give the callsign of the station you are working or one of a group of stations that you are working at the **end** of an exchange.

During a recent DX test, it was remarkable to sit back and listen to the number of stations who never indicated the call of the station they were working. They simply sent their call, a signal report and contest number; the DX station came back with similar information. You could sit there for minutes on end waiting to hear the call of the DX station. When you finally gave up and asked him for his call, you'd probably find out that you'd worked him the day before! Interestingly enough, the sharp operators, the fellows who win the contests, were the ones who were the exceptions—they gave both callsigns at the end of each exchange.

Deliberate interference and incorrect identification are only two of the bad operating practices that you can find on any band you listen to. You can hear any number of stations working cross town on 15 or 20 meters when they should be on 75 or vhf. I have copied distant W/K stations on 20 meters, running well over S9 in New Hampshire, working their neighbors. With modern linears, it's a simple matter to turn the big box off when you don't need it.

Why all the penchant for S9 signal reports when you can maintain perfectly adequate

QSO's with S6 or S7? You may need the linear for a long-haul DX QSO or for making initial contact, but once communication has been established, in 95% of the cases you can turn the linear off with no detriment to the QSO. In some cases, a kilowatt is necessary, but just because you own one doesn't mean you have to use it all the time. It isn't necessary and generates unnecessary interference.

I've heard a lot of stations go QRT because of interference and poor operating practices. This is not the answer. If you hear a station who has a bad signal, is not identifying properly, is causing unnecessary interference or being generally obnoxious, tactfully tell him about it. Most amateurs are gentlemen and will accept your suggestions with grace.

The next time you sit down at the operating desk, take a quick look at the rules of the ARRL A-1 Operator's Club before you turn on the transmitter. Try to follow their basic precepts for general keying and voice techniques, procedure, judgement and courtesy. Strive to be a first class operator; use operating finesse instead of brute force. If you're an A-1 Op, nominate the good operators you hear; if you're not a member of the club, make every effort to qualify. Let's promote good operating on our bands—discourtesy breeds pandemonium.

attention authors

I have a rather good short article in my files describing a unit that uses an integrated circuit—unfortunately, I don't know who wrote it! If you sent in something like this, write and identify it and I'll send you a check forthwith.

When you send in an article for consideration, please make sure your name and address are on the manuscript. It's helpful if you put your name or callsign on the back of each sheet, but that's not absolutely necessary. Same for photos. We haven't lost a manuscript yet, but occasionally an author gets mislaid because the only identification is the return address on an envelope.

Jim Fisk, W1DTY
Editor



bandswitching fet converter

A high-performance
four-band converter
for 10, 15, 20 and
40 meters

Mike Goldstein, VE3GFN, 22 Kingswood Road, Toronto 13, Ontario, Canada

The converter described here was originally designed as the front end of an 80-meter tuner¹ I recently built, the Ethersniffer, Mark II. Great care went into the design of the 80-meter tuner to obtain freedom from cross-modulation and overload, and to ensure good stability and sensitivity. The front end had to perform equally as well, so it wouldn't defeat the work that had gone into the tuner.

It didn't take much to convince me that the FET was the solution to many problems. It had all the advantages of solid state without the problems of the bipolar transistor; the literature shouted its virtue as a mixer, and it was easy to design around. Furthermore, no ham literature had come up with a band-switching FET converter—a chance for a scientific breakthrough was at hand. Slide rule in hand, the foe was engaged.

design

Two problems were presented. First of all, since the converter was all solid-state, I wanted to limit the size of the unit; the size of such circuits seems to be determined by the band-switches. Related to this problem was the desire not to get involved in bandswitching a neutralizing circuit for each band. Since the converter was to cover 500 kHz on each range, it would be wise to be able to peak the rf and mixer circuits. This would provide maximum sensitivity and image-rejection across the band, but demanded a very stable circuit for smooth tuning.

The rf and mixer circuits are basically tuned

to 20 meters, with shunt capacitance switched in to cover 40 meters, and shunt inductance switched in to cover 15 and 10 meters. Careful choice of circuit constants permits one shunt-connected inductor to raise the resonant frequency of the basic tuned circuit such that both higher bands can be tuned, while allowing complete coverage of each lower band (plus a little overlap) with the capacitance range available. The tuned circuits are sufficiently broadband so that tuning is only slightly critical on the upper two bands.

The design of such circuits is reasonably easy, particularly if you use a reactance slide rule. The only pitfall is when you neglect to consider the input capacitance of the FET's plus stray circuit capacitance. Murphy's Law states that you'll always fall into any pits presented, and I conformed.

I should mention here that you should check the operation of these tuned circuits with a grid-dip meter after wiring them. However, since we're using FET's, it will be necessary to remove the FET's from the circuits and substitute a fixed capacitor to represent the FET (about 6 pF should do) before using the grid-dip meter. Connect this capacitor between ground and the point where the FET gate is connected. Be sure to remove the capacitor before putting the FET

back in the circuit.

I didn't feel it was necessary to band-switch a tuned circuit in the oscillator output. Its only purpose would be to present sufficient output load impedance for plenty of oscillator output. Previous experience with a prototype indicated that the problem was to reduce oscillator injection to the mixer, not the reverse, so an rf choke was used as a broad-band load for the oscillator transistor.

As the frequency of operation increases, the reactance of the rfc increases. This makes up for injection losses caused by decreasing oscillator efficiency. High-Q tank circuits in the rf amplifier and mixer minimize any problems caused by undesired harmonics from the oscillator. A simple "gimmick" capacitor (two paralleled wires twisted together for 1/2-inch) provides all the mixer injection necessary.

The second problem was not so much solved as ignored. I had hoped that with sufficient shielding and decoupling, it wouldn't be necessary to neutralize the rf amplifier to obtain the desired stability. This "head in the clouds" attitude was almost the undoing of the project, because the converter developed instability early in the game. Nothing (short of neutralizing) seemed to help until in desperation I took a look at the basic principles.

Experiments indicated that the feedback was caused by capacitance within the FET itself; I had defeated all coupling between circuits long-ago. How then, to eliminate this troublesome capacitance? A look at the specs on the Motorola MPF105 FET (my old faithful) indicated a reverse transfer capacitance of 3 pF. This seemed to be the dragon to slay. A quick call to the Motorola man yielded specs on a new MOSFET with all the desirable qualities of my MPF 105 JFET, plus a reverse transfer capacitance rating of less than 0.2 pF. A quick substitution, and the problem was solved.

construction

The converter was built on an aluminum chassis 5-3/4-inches wide, 7-inches deep and 3-inches high, the size dictated by the size of the bandswitch. The cabinet is a Ham-

The MOSFET converter and 80-meter tuner—a complete high-frequency receiving set-up.

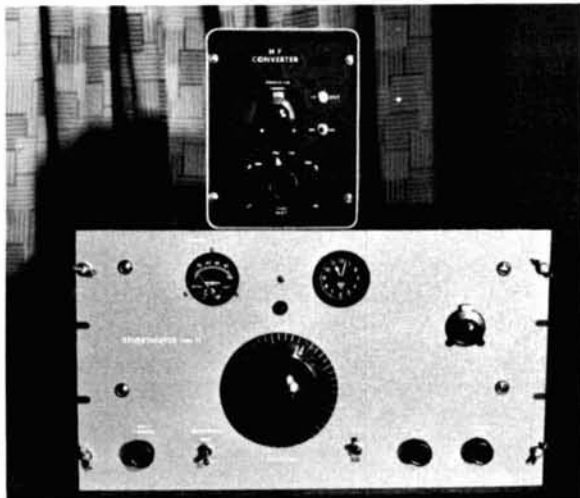

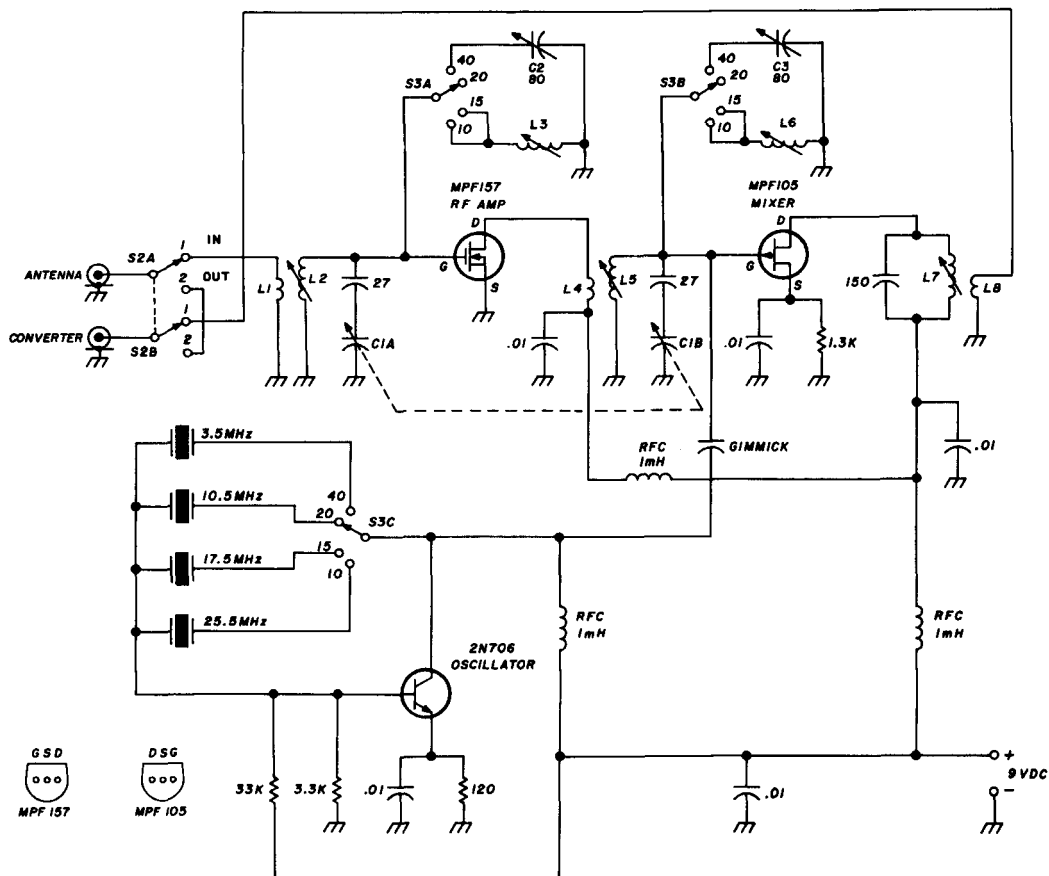

- | | | | |
|---------------|--|-----------|---|
| C1 | 2-section variable, 7-72 pF (Millen 21075-R) | L7 | 11 μ H. 40 turns number 36 closewound on a 1/4" slug-tuned form |
| L1, L4 | 5 turns number 26 closewound on the cold ends of L2 and L5 | L8 | 12 turns number 28 enamel on cold end of L7 |
| L2, L5 | 6 μ H. (CTC 2084-2) 25 turns number 26 enamel closewound on a 1/4" slug-tuned form | S1 | SPST toggle switch (in power supply) |
| L3, L6 | 22 turns number 28 enamel closewound on a 1/4" slug-tuned form | S2 | DPST toggle switch |
| | | S3 | 3P4T ceramic rotary switch (Centralab 2008) |

fig. 1. Bandswitching MOSFET converter for 40, 20, 15 and 10. A war-surplus variable was used for C1, but the Millen 21075-R is a close equivalent.

mond 1401-B*, which just accommodates my home-bent chassis nicely. The shields shown in the photograph were custom shaped with a nibbling tool after installing the band-
 *If you can't locate a Hammond distributor, the Bud WA-1540 Portacab is a reasonable facsimile. Available for \$10.60 plus postage from Allied Radio, 100 North Western Avenue, Chicago, Illinois 60680. Weight, 2-1/2 pounds.

switch.
 The wiring is shown in the photographs; it is not critical, but it's a good idea to keep all the leads as short as possible. Solidly mounting all components will result in good mechanical stability. I didn't use any "special" components, so it should be reasonably inexpensive to duplicate.

alignment

Alignment is simple. Switch the converter to the 20-meter range, and tune the i-f amplifier to 3650 kHz (14,150 kHz). Set the converter tuning capacitor to half-mesh. With a signal generator (or a received signal) at the input, adjust both rf amplifier tuned circuits for maximum signal output from the i-f amplifier. Adjust the mixer circuit first. Now peak the mixer output circuit for maximum signal output. This completes 20-meter alignment.

Set the converter to the 40-meter range.

fig. 2. Power supply for the bandswitching converter. T1 is a Knight 54E1416 or similar; the diodes can be anything that will handle 150 mils.

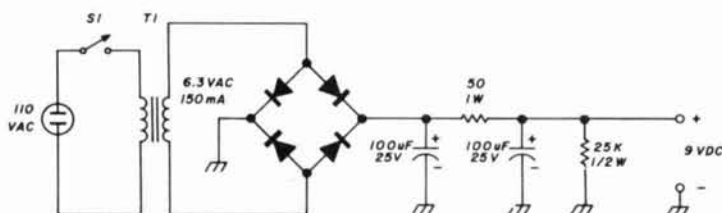

With a suitable input signal, adjust the shunt capacitor in the mixer circuit until the correct mixer beat is found, then adjust it for maximum signal output. Now, adjust the rf amplifier circuit for maximum signal output. This completes the 40-meter alignment.

Under the converter chassis. The mixer section is to the right near the front panel; the rf amplifier is toward the rear. The power supply components are mounted on the rear deck. Only three sections of the rotary switch are used.

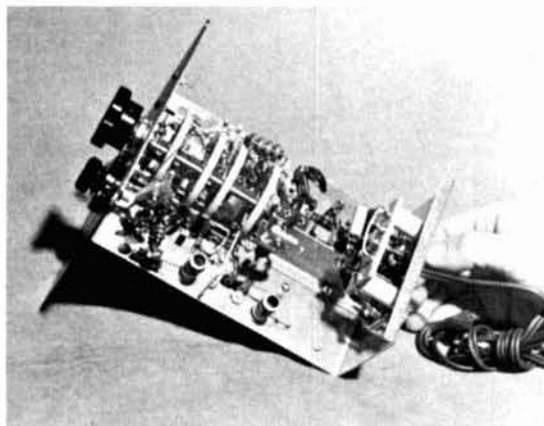

Alignment of the top two bands is a bit touchy because they are both covered by the same tuned circuits. However, with a little care, disaster can be avoided. Set the converter to 15 meters. Adjust the tuning capacitor for maximum mesh, and set the i-f amplifier for 3500 kHz (21,000 kHz). Tune the shunt inductance in the mixer circuit until the correct mixer beat is found, then adjust it for maximum received signal. Adjust the rf amplifier the same way. Now switch to the 10-meter position. If the tuned circuits are correctly aligned, it should be possible to peak up received signals on the bottom

end of the 10-meter band with the tuning capacitor set close to minimum mesh. This completes converter alignment.

The photographs were taken before the shunt inductances were wired in; they are installed adjacent to the 20-meter coils. Room was provided for a total of five crystal sockets.

performance

Performance of the converter has been quite satisfactory. It shows no tendency to overload whatsoever, is extremely quiet, and quite sensitive. Once the tuned circuits are set to the middle of a band, operation over the entire band is possible without repeaking them. However, peaking them on a weak one does improve matters. No spurious signals have been detected in the i-f amplifier when the tuned circuits were properly peaked. The tuning is very smooth and there is no evidence of instability.

ham radio

references

1. M. Goldstein, VE3GFN, G. Cousins, VE1TG, "High Quality Hybrid Receiver," 73, February, 1968, p. 42.

an ultrastable solid-state 10-watt 28-mhz transmitter

Due to the perseverance of ITT's Gary Jordan—who should be credited for unearthing this unusual variable-frequency oscillator amid reams of British and Czechoslovakian technical literature—amateur designers now have at their disposal a VFO described by *The Electronic Engineer* as “the first oscillator showing promise of eclipsing performance of all other self-sustained oscillators.”¹ The VFO actually uses a single transistor in a circuit with all appearances of a Clapp oscillator, except that the method of feedback is different.

exceptional stability

Three distinct performance characteristics combine to make the Vackar concept highly desirable. First, it has the greatest inherent stability of any known VFO design other than that with an independent external load feedback. Second, it can tune over a frequency range of nearly 3:1. Third—and especially significant for amateur purposes—the output over that frequency range is absolutely constant.

As with any unusual oscillator, however, problems have been encountered. The Vackar has a tendency to oscillate at audio frequencies simultaneously with rf generation. This problem can be overcome by decoupling the base-bias resistors from the collector load resistor—using an appropriate value resistor—and not an rf choke. A resistor will attenuate both audio and rf feedback simultaneously; an rf choke will not. As a precaution-

ary move, it is also helpful to bypass the emitter both at audio frequencies and rf frequencies, although this is not absolutely necessary.

putting the Vackar on the air

Getting down to brass tacks, the extremely stable characteristics of the Vackar lends itself to hf applications where conventional designs fear to tread. The basic circuit is shown in *fig. 1*, adapted from Vackar's original concept (illustrated in *fig. 2*).

fig. 1. Want just the VFO? Here's a Vackar you can put to work immediately. Choose a 25-MHz coil/capacitor combination and you'll have stable drive available for your 6-meter transmitter.

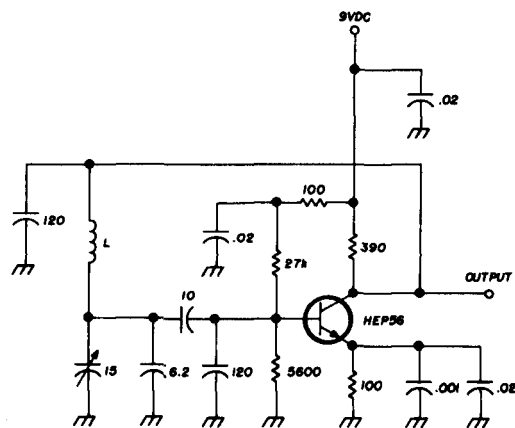

Robert M. Brown, K2ZSQ/W9HBF, 5611 Middaugh Avenue, Downers Grove, Illinois 60515

fig. 2. Jiri Vackar's original oscillator circuit, developed in Czechoslovakia in 1949. British and American engineers now tout it as one of the most brilliant VFO circuits ever devised.

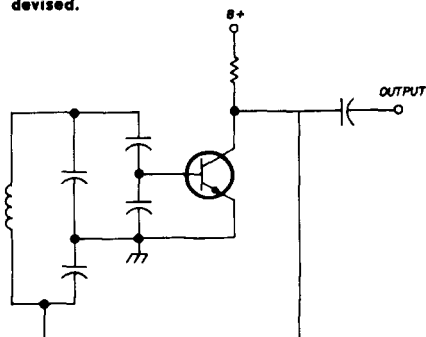

A conventional small power amplifier chain has been built providing a power output of approximately 10 watts over the 28-MHz ham band. No creative claims are made for this portion, since it was constructed mainly of scrounged components found around the work-bench.

Standard VFO isolation techniques should

be observed, of course. Decoupling has been included in the circuit to minimize audio oscillation and an emitter follower provides isolation. The final tank circuit uses a pi-L circuit with a capacitive divider to match the transistor output impedance. The transmitter can be built in a small mini-box equipped with wall-divider sections as indicated in the schematic.

performance

As a hf VFO, few designs can compare with the Vackar in stability and constancy of output over a wide frequency range. The ten-meter CW transmitter shown here can provide long hours of enjoyment to the ten-meter DX fraternity.

references

1. G. B. Jordan, "The Vackar VFO, a design to try," *The Electronic Engineer*, February, 1968, p. 56.
2. J. R. Fisk, WIDTY, "Stable Transistor VFO's," *ham radio*, June 1968, p. 14.
3. J. Vackar, "L-C Oscillators and their Frequency Stability," *Tesla Tech Reports*, (Czechoslovakia), December, 1949.

ham radio

fig. 3. Circuit of a 28-MHz transmitter using a Vackar VFO. Power output to the antenna is 10 watts.

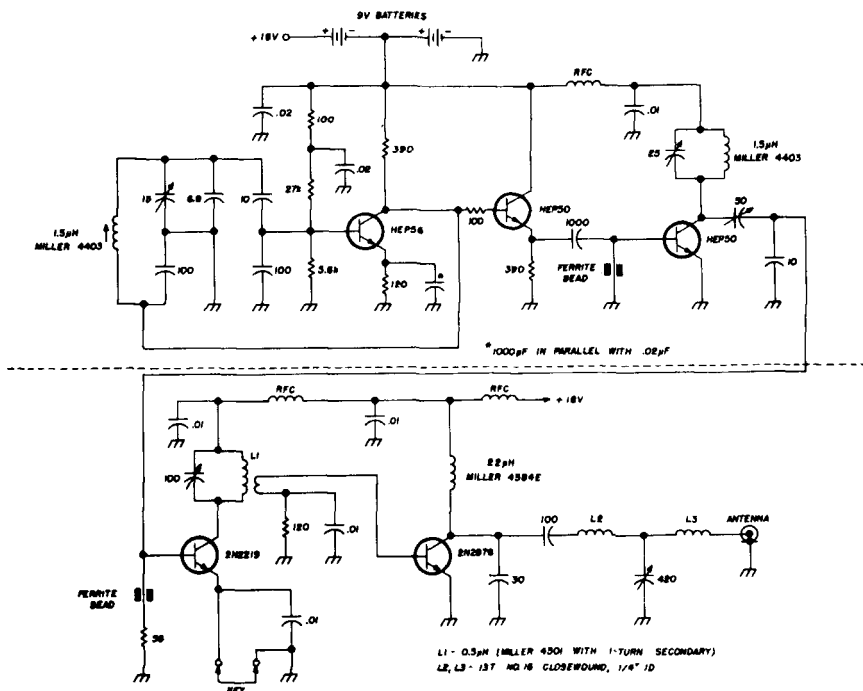

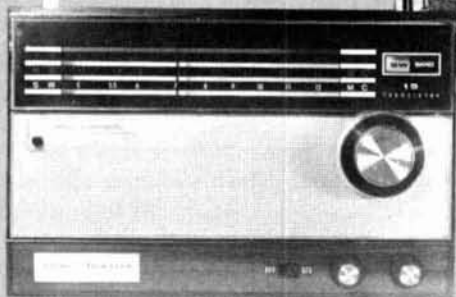

transistorized 455-kHz bfo

A stable
outboard
BFO
for use with
transistor radios

Ed Murriner, W6BLZ, and John Meredith, K5GXR/6, 528 Colima Street, La Jolla, California

Probably a lot of radio amateurs took advantage of the all-band transistor radio recently offered by a national oil company at a special low price of \$39.00. The brochure they sent out showed a receiver with a vernier tuning rate and bandspread on 160, 80 and 40 meters of about one inch. Obviously, here was a portable radio that had all the possibilities of a picnic-table portable. All you needed to copy CW was a BFO. Needless to say, we bought the receiver.

The next step was to search through all of the old literature for a transistor BFO, and about a dozen circuits were found. However, none of them wanted to oscillate after they were built. K5GXR/6 took up the problem. With a Tektronix Oscilloscope, a frequency counter, a grid-dip oscillator, a variable-voltage power supply and some substitutions from the junk box, he did manage to make a BFO work. Kibitzing on the side by other amateurs who were digital-circuit engineers

Internal layout of the bfo.

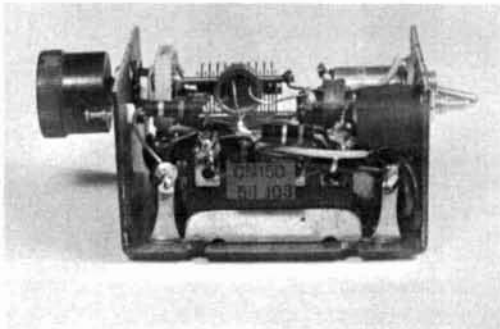

also helped to make the project a success. By a process of elimination, the circuit described here seemed like the one most likely to succeed for the amateur with no test gear. A grid-dip oscillator or low-frequency receiver is a help if the tank circuit is very far off the design frequency of 455 kHz.

construction

The BFO was built in an aluminum box 2-1/4 x 1-1/2 x 1-3/8 inches; LMB type MOO. At first we were going to build the unit in a plastic box, as in other articles, to take advantage of radiation coupling into the receiver. This idea did not work out because hand capacity made the signals wobble. In addition, the tuning capacitor had to be fastened down to the shield can for the same reason.

This unit was built quite small and you can see from the photographs that the parts are crammed into a tiny space. Some builders might want more room, but nimble fingers should have no trouble soldering all the parts in place. All the holes were drilled by rule of thumb, a weather eye, and a little hand fitting. A four-terminal mounting strip was used to tie down the components.

It's a good idea to hook up the coil and capacitors and tune them to frequency before putting them in the box. Because of the low frequency, the coils are low Q, and some 1-mH slugged-tuned coils don't seem to tune. Once the circuit dips, put it in the box. After the oscillator is finished, set the variable capacitor mid-scale and adjust the coil slug to 455 kHz.

Use the same components that are called

The parts are crowded, but they'll all fit.

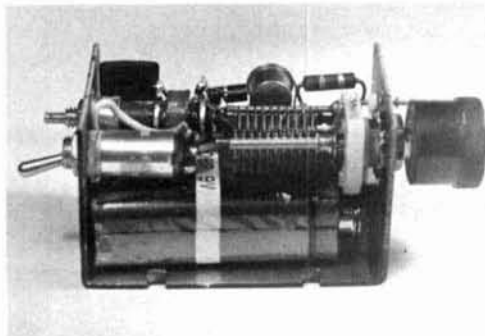

out on the drawing. Several of these units have been built and they all worked. It took a lot of fiddling to find the proper values, so don't duplicate our mistake by thinking something else will work—it might not!

The oscillator will run on any supply voltage between three and nine volts. The 9-volt battery was used because it fit into the bottom of the chassis box very nicely.

testing

About all that can be said about testing the unit is to set the capacitor half scale and turn the unit on. Hold it near the transistor radio or connect a wire from the feedthrough insulator to a piece of hookup wire wrapped around the transistor-radio antenna. This will couple in enough signal to beat with the i-f signal. Vary the coil slug until a zero beat is

fig. 1. Schematic diagram for the 455-kHz bfo. The two capacitors in the tank circuit should be silver-mica types.

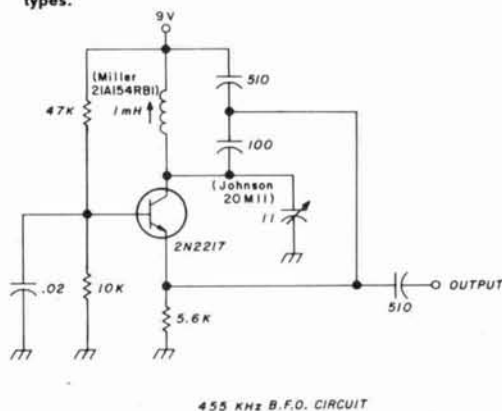

received. Use the capacitor for fine adjustments. A wobbly signal is due to an unstable transistor radio; the BFO is quite stable. Tests over a three-hour period indicated a total drift of 186 Hz.

This circuit can be used for other oscillator frequencies by scaling down the LC ratio. Remember that the total tuning capacitance is in series across the coil and the total capacitance of the circuit is less than the smallest capacitor. While we didn't experiment with this circuit on higher frequencies, it seems like the easiest one that will oscillate.

ham radio

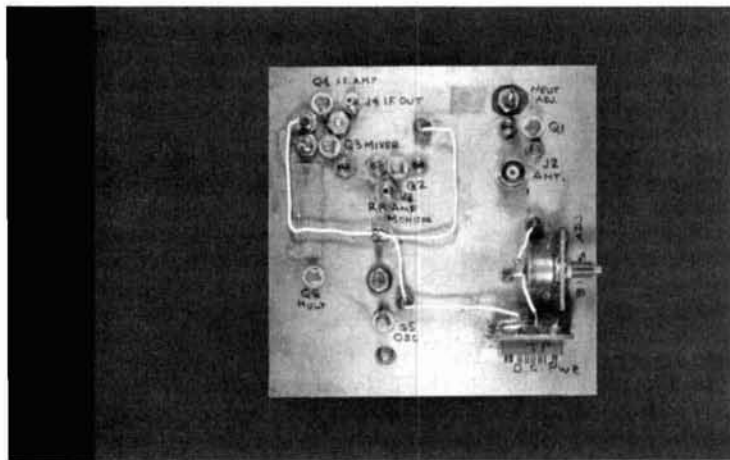

1.5-dB noise figure on two meters

Complete construction
details for a high-
performance FET converter
for two meters

Bob Kolb, WA6SXC, 1300 West Oak Avenue, Fullerton, California 92633

I've built quite a few converters over the years, and I have to chuckle when I think of my first attempt. It was a single 12A7 on six meters. I used 12-volts dc on the plates and filaments and down-converted to the broadcast receiver in my car. Other operators could hear my local oscillator radiating a mile away. My next endeavor used those new-fangled nuvistors on two meters. I really thought I had something! I built another unit for 432 and felt pretty smug.

Then noise figure became the rage. You just weren't in the "in crowd" unless your noise figure was less than 3 dB on two or 4.5 dB on 432. So, I got some 7077 ceramic triodes and built some preamps. I finally made the grade, but the fad switched to transistors; out came the soldering iron and the old 7077 preamps were replaced with 2N2857's, but there wasn't too much improvement in noise figure. I thought I was through for a while, but someone started making junction FET's for vhf. I tried a 2N3823 on two meters but was unimpressed; I wasn't pleased with TIS 34's in cascade either.

Then I built the 432-MHz receiver front end for the ill-fated ARIES satellite program

and tried several varieties of exotic bipolar transistors. When the 2N4416 and 2N4417 junction FET's became available, I decided to try them. The results were astonishing. The 432-MHz converter design I came up with was published in the May, 1968 edition of **ham radio**.¹ Right afterwards, I began building the 2-meter converter described here.

the converter

This converter is an exceptional performer. It has a 5-MHz, 3-dB bandwidth and a calculated 1.52-dB noise figure. It will copy a carrier modulated 30% with 1 kHz at a level lower than -127 dBm (less than 0.1 μ V). When 98- to 138- and 150- to 180-MHz signals at 0 dBm (1 mW) were inserted into the antenna connector, no output was detected when a field intensity meter (sensitivity less than -85 dBm) was tuned across the i-f band. Noise figure was determined by measuring an i-f signal 3 dB above the noise with a -121-dBm input modulated 30% with 1 kHz. A Stoddard NM-30A calibrated receiver with a 3-dB bandwidth of 140 kHz was used as the tunable i-f as shown in **fig. 3**.

Parts layout of the 2-meter converter. The local-oscillator chain and mixer are to the left, the rf amplifier stages to the lower right. The shield partitions in the rf stages are constructed across the center of the transistor sockets.

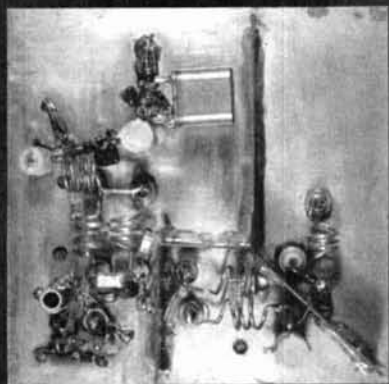

circuit description

The rf amplifier section is a cascode arrangement using a neutralized common-source stage followed by a common-gate amplifier. The two stages are coupled inductively, but C1 was added to increase circuit bandwidth by overcoupling. FET's behave somewhat like tubes and have high input impedance. The loaded Q's are much higher than bipolar transistor circuits, and broad bandwidths are difficult to achieve without overcoupling. The increased coupling also in-

fig. 1. Bandpass characteristic of the converter. The 3-dB bandwidth is from 143 to 148 MHz; and 1-dB bandwidth is from 144.8 to 147.0 MHz. Gain at 146 MHz is 21 dB.

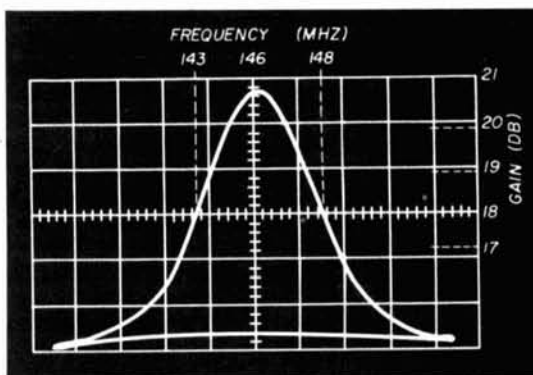

creases the load on Q1 and makes the stage more stable and easier to neutralize.

The bandpass of the rf amplifiers as measured at the rf amplifier monitor jack (J3) is shown in **fig. 1**. If you're only interested in operating in the first one megahertz of the two-meter band, omit C1. The same coupling technique is used between the rf amplifiers and the mixer. The output of the mixer is applied to an untuned amplifier to drive the coax to the receiver and isolate it from the receiver input circuit. The mixer is operated slightly above pinchoff where it is fairly non-linear.

The i-f for this converter was chosen for the 29.5- to 34.5-MHz converter band on the NC-300 receiver. However, the oscillator will tune to 38.6667 MHz, and C4 can be adjusted

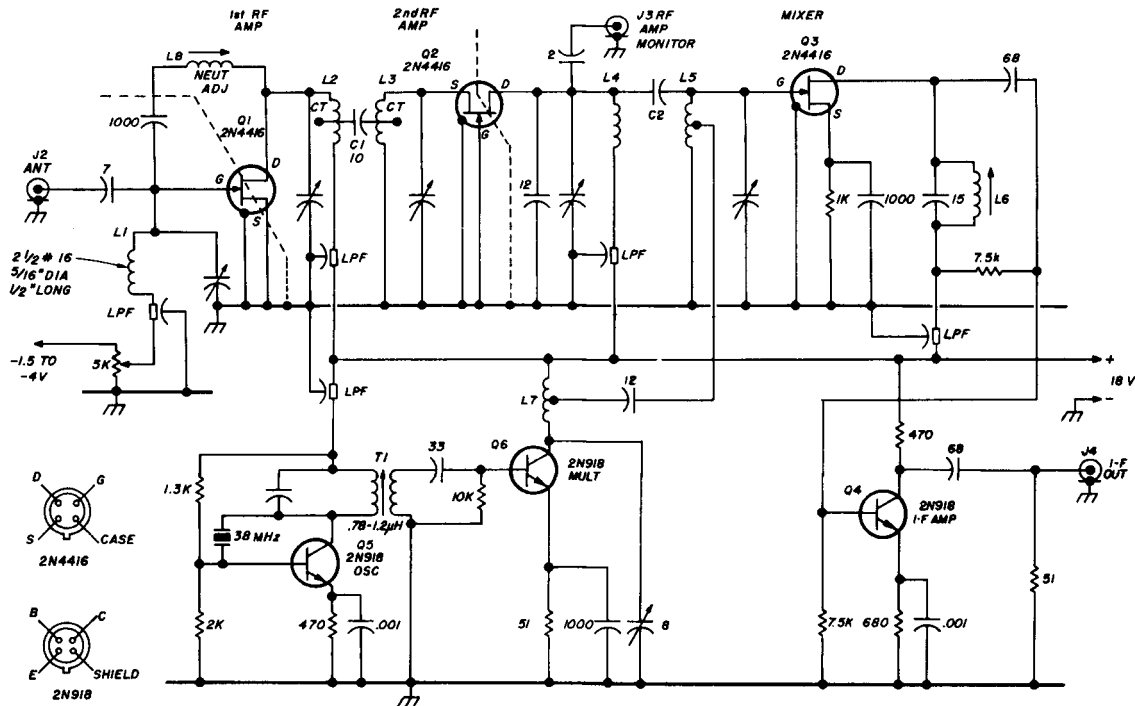

- | | |
|--|--|
| <p>L1 2-1/2 turns number 16, space wound, 5/16" diameter, 1/2" long</p> <p>L2, L3, L4 3 turns number 16, space wound, 5/16" diameter, 1/2" long</p> <p>L5 4 turns number 16, space wound, 5/16" diameter, 1/2" long, tapped 1-1/2 turns from cold end</p> | <p>L6 20 turns number 24 on 1/4" ceramic form (CTC PLS-6 with white core)</p> <p>L7 4-1/2 turns number 16, 5/16" diameter, 1/2" long, tapped 2 turns from B+ end</p> <p>L8 1.7 to 2.7 μH (J. W. Miller 4503)</p> <p>T1 0.78 to 1.2 μH (Vanguard LT4J-7206)</p> |
|--|--|

fig. 2. Schematic diagram of the low-noise converter for two meters. Except as noted otherwise, all variable capacitors are 10-pF pistons (Johanson JMC-2954); LPF's are feedthrough filters (Allen Bradley SMFB-A2 or Erie 1201-050).

for 116-MHz output from the multiplier. This will produce a 28-MHz i-f at 144. Transistors such as the 2N918, 2N3564, 2N4324, and 2N2369 have been used with equal success in the oscillator, i-f, amplifier and multiplier circuits. The 2N3564 and 2N4324 are low-cost epoxy types.

The photos show a breadboard model of the converter. Each stage was evaluated independently and then the connectors were removed except for the rf amplifier-monitor jack (J3). You can see the extra holes in the breadboard. Optimum local-oscillator power is approximately +13 dBm or 20 mW. This

may sound quite high, but the LO is very lightly coupled into the mixer to maximize LO isolation.

construction details

After considerable discussion with W6DQJ, I decided to use sockets for the transistors; this was in opposition to my personal preference. My attitude in this regard has only been strengthened by this experience. The use of a socket invites intermittents unless you solder the transistor to the socket. Another version under construction at this time will use no sockets or holders of any kind; only

standoff terminals. The transistor will be soldered upside down as shown in **fig. 4** with its leads soldered to the terminals above the other components. With this arrangement,

fig. 3. Test setup used to measure the sensitivity of the two-meter converter. Noise figure of the unit was calculated to be 1.52 dB.

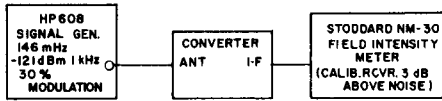

replacement or substitution of transistors is quite easy.

At the expense of being considered unsophisticated, I wound all the coils except L6 and L8 around the handle of a standard X-acto knife (5/16-inch diameter). The turns were spaced approximately 1/8-inch apart with the blade of a pocket screw driver. The chassis is 1/16-inch epoxy-glass printed-cir-

fig. 4. Method used for mounting the transistors when sockets aren't used.

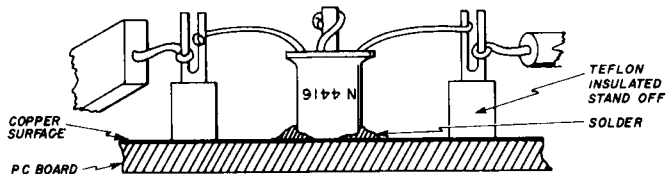

cuit board. All capacitors were glass (CY10 series) or 2% mylar Elmenco DM15's.

It is important to strip the copper from around L8 so that the mounting nut does not contact ground because the tuning slug of L8 **must** be isolated from ground. Transformer T1 is a Vanguard LT64 series-tunable transformer (0.8-1.2 μ H). All dc lines were bypassed with Allen Bradley FMB-A2 low-pass feedthrough filters, but I have found the Erie 1201-050 filters are also satisfactory. Standard tefflon feedthrough terminals may be used if the dc points are interconnected with 10- μ H inductors or Ohmite Z144 rf chokes. All feedthroughs should be bypassed with 1000-pF disc ceramic capacitors with zero lead lengths.

The chassis is 5-inches square with 1/32-inch thick x .950-inch high partitions. The

source and case connections to Q1 and the gate and case connections to Q2 are soldered directly to the shield. A small hole (about .040-inch diameter) is drilled through the shield and the copper around it is removed in a 1/8-inch diameter circle to allow the lead from the 1000-pF capacitor in the neutralizing circuit to be connected to L8.

The drains of both Q1 and Q2 must be shielded from their gates and sources. All air-wound inductors are mounted with their center lines parallel with and 0.3 inches above the chassis as shown in **fig. 5**. All insulated standoff terminals are the press-in tefflon type. All 1000-pF emitter and source bypass capacitors are 50-V disc-ceramic types with zero lead lengths. The crystal is connected into the circuit by tube-socket jacks removed from a phenolic 7-pin miniature tube socket. These work well with the HC-6/U crystal holders.

The copper can be removed quite easily from the printed-circuit board by cutting the outline of the area to be removed with an

X-acto knife and lifting out the area with the tip of the knife as hot solder is flowed over the area. All ground connections were made

fig. 5. Mounting the air-wound inductors used in the converter.



directly to the nearest point on the board. The addition of the i-f amplifier was an afterthought; hence, the circuit is a little crowded.

tune up

Connect the B⁺ so that you can monitor the drain current (I_D) of Q1 (10-mA meter in

fig. 6. Layout of the copper-clad board used in the 144-MHz converter. The power connector (J1) is mounted on one vertical upright; the 5k bias-adjust pot on the other.

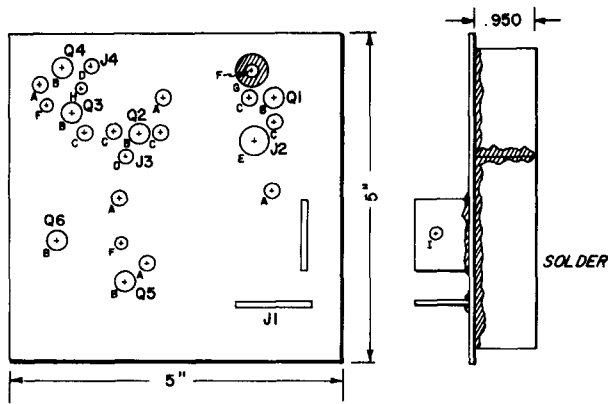

- A .213" FOR FMB-A2 LOW-PASS FILTER
- B 5/16" FOR TRANSISTOR SOCKETS
- C .228" #1 FOR JMC-2954 CAPACITOR
- D .189" FOR SELECTRO #3102 CONNECTOR
- E 3/8" FOR BNC CONNECTOR (J2)
- F 5/32" FOR L8, L6, & T1
- G 1/2" DIA. COPPER STRIPPED FROM BOTH SIDES OF BOARD
- H #28 FOR 1000- μ F STANDOFF CAPACITOR
- I 1/4" FOR BIAS ADJUST

series with +18V and LPF2). Connect the negative supply voltage and the antenna. Set the bias-adjust pot for 5 mA of drain current for Q1. Set the input trimmer capacitor at about midrange and the drain tank capacitor about 75% in with L8 nearly out. Rock L8 back and forth and make certain the drain current stays steady. Disconnect the antenna, and note any change in the drain current of the first stage (I_{D1}); if I_{D1} changes, Q1 is not neutralized. Repeat the adjustment of the two tank circuits and L8 with the antenna alternately connected and open circuited until I_{D1} is stable at 5 mA. Attempts to neutralize Q1 by minimizing the signal through it with-

out B+ applied will not work because junction capacitance changes significantly when B+ is applied.

The oscillator and multiplier are tuned by monitoring the dc voltage on the multiplier emitter resistor. Next, apply a signal to J2, and successively tune each circuit for optimum. Finally, tune in a weak station, and tune for maximum; then sit back and enjoy that well-earned QSO.

reference

1. R. Kolb, WA6SXC, "A Low-Noise 432-MHz FET Converter," *ham radio*, May, 1968, p. 18.

ham radio

optimizing vhf converter performance

At this time of year a lot of vhf enthusiasts are getting ready for the DX season by putting up new antennas, replacing old gear, etc. During the big revamp, why not check the B+ feeding your converter? Few amateurs realize that most commercial converters (and many homebrew jobs) are overdriven to the point of decreased performance.

The B+ feeding the converter can be adjusted for optimum S/N ratio by inserting a pot temporarily in the line. With careful adjustment, you can often get 1 dB or more on

weak signals and up to 7 dB on the stronger ones. After you've optimized the size of the resistance, you can replace it with a fixed value.

This is also a good time to get your signal generator out and tweak everything for maximum. Don't forget noise figure; it's important to keep it as low as possible. If the noise figure is reduced from 15 dB—a not uncommon figure—to 5 dB, it is the same as increasing the power of the signal you're listening to by 10 times.

ham radio

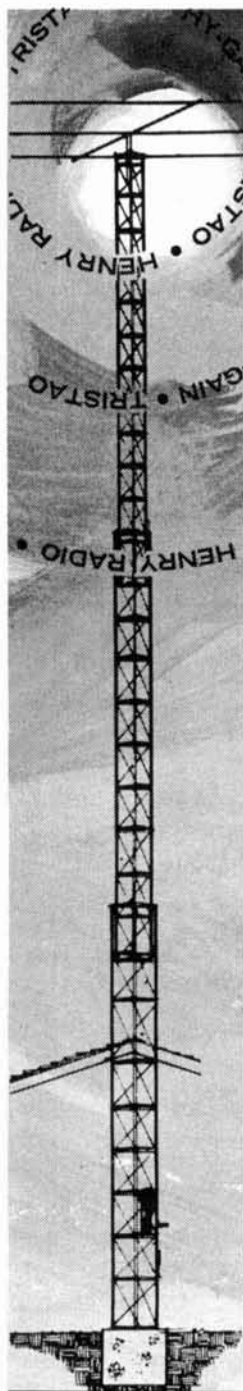

Henry Radio Presents

A NEW CONCEPT IN ITS EXCITING BEAM ANTENNA PROGRAM

Any knowledgeable DX'er will tell you the secret is in the antenna. For over a year Henry Radio has provided an exciting beam antenna package program allowing the average amateur to own an efficient, and unbelievably economical antenna package . . . pre-engineered, pre-matched and pre-packaged to suit his pocketbook and requirements. NOW! This world famous antenna program moves forward. NOW! You can have the antenna of your choice at the same incredible saving.

Basic package No. HR-1

***Tristao CZ-337 New concept 40 ft. crank-up tower w/mast
CDR TR-44 rotator
100 ft. RG-58 A/U Coax
100 ft. Control cable**

Complete with one of the following:

Hy-Gain TH-3 Jr. antenna \$325.00
Hy-Gain TH-2 Mk 3 antenna \$325.00
Hy-Gain DB 10-15A antenna \$325.00
Hy-Gain 203BA antenna \$330.00
Hy-Gain TH-3 Mk 3 antenna \$375.00

A savings of approximately \$70.00

Basic package No. HR-2

***Tristao CZ-454 New Concept 60 ft. crank-up tower w/mast
CDR TR-44 rotator
100 ft. RG-58 A/U Coax
100 ft. Control cable**

Complete with one of the following:

Hy-Gain TH-3 Jr. antenna \$480.00
Hy-Gain TH-2 Mk 3 antenna \$480.00
Hy-Gain DB 10-15A antenna \$480.00
Hy-Gain 203BA antenna \$485.00
Hy-Gain TH-3 Mk 3 antenna \$520.00

A savings of approximately \$90.00

Basic package No. HR-3

***Tristao CZ-454 New Concept 60 ft. crank-up tower w/mast
CDR Ham-M rotator
100 ft. RG-8/U Coax
100 ft. Control cable**

Complete with one of the following:

Hy-Gain TH-3 Mk 3 antenna \$560.00
Hy-Gain 204 BA antenna \$565.00
Hy-Gain 402 BA antenna \$575.00
Hy-Gain TH-6 DXX antenna \$590.00
Hy-Gain DB-24B antenna \$620.00

A savings of approximately \$120.00

***Free standing tower \$10.00 extra**

All complete packages are priced freight prepaid to your door in the continental U.S.A. Substitutions may be made . . . write for prices. And remember, you can buy on time. You can trade your used transmitter or receiver. You can rely on Henry Radio to supply the finest equipment and the best value.

CALL DIRECT . . . USE AREA CODE

Henry Radio Stores

Butler, Missouri, 64730

816 679-3127

11240 W. Olympic, Los Angeles, Calif., 90064

213 477-6701

931 N. Euclid, Anaheim, Calif., 92801

714 772-9200

"World's Largest Distributor of Amateur Radio Equipment"

phase-shift ssb generators

There's more than one way
to generate a ssb signal—
the filter method
was covered earlier:
here's how
the phase-shift method
works

There are two ways to generate a single-sideband signal. In the one most popularly used, a double-sideband suppressed-carrier (dsb-sc) signal is first developed by feeding an rf signal and an af signal into a balanced modulator. The dsb-sc signal is then passed through a filter that removes one sideband. This is known as the **filter method** of obtaining an ssb signal.

The other way, seldom found in commercial ham equipment today, is called the **phase shift method**. The rf and the af signals are fed to a pair of balanced modulators, introducing enough phase shift in each so that, when the resultant is finally mixed, one sideband and the carrier are suppressed. Phase-shift ssb generation has been a mystery to many readers. Therefore, no series of articles on single-sideband would be really complete without a detailed explanation of how the phase-shift method works.

advantages and disadvantages

One of the major advantages of the phase-shift method of generating a single-sideband signal is that the method can be used at any frequency. In the filter method, an rf signal is used initially. After one sideband is removed, several stages of frequency translation are usually necessary to bring the ssb transmitter signal to a high or very-high frequency. Additional filters may also be needed, because every time the signal goes through a stage of translation, another double-sideband signal is generated (unless a balanced mixer is used). With the phase-shift system, the single-sideband signal can be generated right

Forest H. Belt, 119 Baker Avenue, South Plainfield, New Jersey 07080

at the transmitter output frequency, even if it is all the way up in the vhf range.

The system isn't used much in commercial ham radio gear for two major reasons. In the first place, sideband and carrier suppression are not as thorough as with a well designed and properly adjusted filter system. A good filter-type single-sideband exciter can achieve carrier suppression from 40 to 60 dB, depending on the type of balanced modulator used. In the phase-shift generator, only the best design can achieve more than 30 or 35 dB of suppression.

This is adequate for practical use, and yet it can be a little annoying in crowded ham bands. A bit better suppression can be achieved with special tubes such as the RCA

phase-shift method may actually be cheaper in vhf and uhf equipment.

For another thing, careful attention must be paid to the design of rf and af circuits, because the quality of suppression depends on precise phase-shifting. This is particularly true in the voice-signal bands where a range of frequencies from 100 to 3000 Hz must be handled exactly the same—phase-shifted the same amount. Since phase-shift networks are inherently frequency-sensitive, only careful design can keep them flat over so broad a ratio of low-to-high audio frequencies.

Furthermore, speech amplifier circuits must be very flat in response, and can introduce no phase shift of their own. If higher frequencies are phase-shifted more or less than those at

fig. 1. Block diagram of a phase-shift exciter for upper-sideband operation on 14.25 MHz.

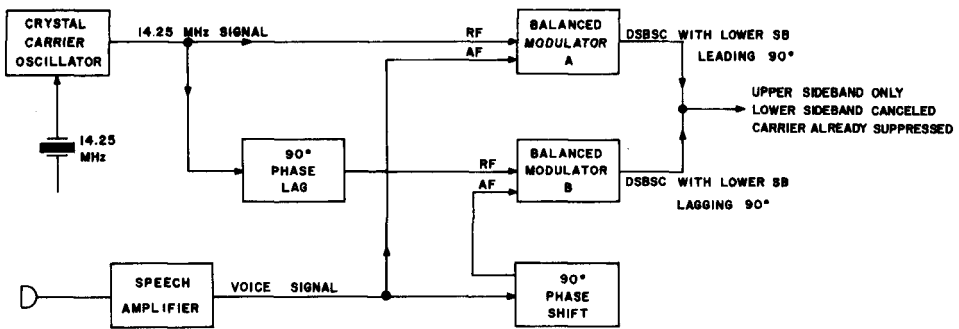

7360, but even that depends on critical adjustment of the circuit.

Which brings us to the second major reason why phase-shift ssb generation isn't very common in ham equipment. It is difficult to adjust properly. Later in this article, we'll discuss some principles of adjusting this type of single-sideband exciter. You'll see that correct adjustment does require a sound technical knowledge of how the circuit and the system works, and that it takes more time and test equipment than the less critical filter method.

There are other reasons for the lack of interest in phase-shift ssb in commercial ham equipment. In hf gear, cost is usually a little higher, because at least one extra circuit is required. However, a vhf transmitter would require extra stages and extra crystals anyway, for frequency translation; in the long run, the

low end of the range, poor sideband suppression results. Even amplitude attenuation at certain frequencies may create balance problems that could upset the complete phase cancellation upon which sideband suppression depends.

principles of phase-shift ssb

To clarify how a single-sideband signal is generated by phase shift, most explanations incorporate vectors. I propose to explain the operation without using mathematics, but to do so I'll have to break up the explanation into two parts. First, you'll get an overall view of the system, using the block diagram in fig. 1, and then a more detailed analysis of just how phase shift cancels one of the sidebands.

For the sake of this explanation, assume the ssb generator is to furnish a single-sideband signal at 14.25 MHz. A crystal oscillator

initiates the 14.25-MHz carrier signal. In the simplest phase-shift system, the rf signal is sent in two directions. In one direction, the signal is applied directly to the rf input of a balanced modulator, which is labeled A. The other portion of the 14.25-MHz signal goes through a phase-shift network which retards its phase by exactly 90°. This phase-shifted rf signal is then applied to the second balanced modulator, which is modulator B.

Meanwhile, the voice signal has been processed by the speech amplifier. It is also split, with one portion being fed directly to modulator A and the other being phase-shifted by 90° and fed to modulator B. In some transmitters, this 90° phase separation is accomplished by shifting one af signal forward by 45° and the other backward by 45°. The important thing is that the two voice signals applied to the separate balanced modulators be exactly 90° apart.

The way balanced modulators work was explained in an earlier article.¹ Therefore, you should already understand how a double-sideband suppressed-carrier (dsb-sc) signal develops in each balanced modulator. Actually, for our purpose, it is sufficient to know that the output from balanced modulator A consists of a double-sideband suppressed-carrier signal. The important difference between it and the output of an ordinary balanced modulator is that the lower sideband is effectively 90° out of phase with the upper sideband. An interesting point—and one to remember.

From modulator B, the out-of-phase sideband relationship also exists. The upper sideband from B is in the same phase as the upper sideband from modulator A. However, modulator B's lower sideband is effectively 90° out of phase with its upper sideband, but in the **opposite** direction from that of the lower sideband from modulator A.

With one lower sideband lagging by 90°, and the other leading by 90°, the two lower sidebands are obviously 180° out of phase with each other. Meanwhile, both upper-sideband signals are in phase with each other, and reinforce the upper sideband. When the outputs of the two balanced modulators are combined, only the upper sideband is produced; the two lower sidebands cancel each other. Of course, the 14.25-MHz carrier signals were

anceled in each balanced modulator, by normal balanced-modulator action.

Now, summarizing this generalized description of the effective action of phase-shift single-sideband generation depicted in **fig. 1**: the rf signal is split and one part of it shifted in phase by 90°; the two signals are applied to separate balanced modulators. The af or voice signal is also split into two parts that are separated by 90° and fed to the two balanced modulators. The output of one modulator has one of its sidebands leading by 90°; the same sideband from the other modulator is lagging by 90°. As a result, when the outputs are mixed, that sideband is canceled. The other remains, and is the single-sideband output of the generator. The carriers are eliminated by regular balanced-modulator operation.

The system shown in **fig. 1** generates an upper sideband. All that is necessary to make it generate a lower sideband is to reverse the phase of the 14.25-MHz carrier fed to modulator B. That is, instead of it lagging the signal of modulator A by 90°, it is made to **lead** the signal by 90°. When the signals come out of the two modulators and are mixed, the lower sideband is reinforced, and the two upper sidebands are 180° out of phase and therefore cancel.

how the sidebands cancel

Now for the detailed analysis I promised, which can help explain further how just one sideband is developed in the system of **fig. 1**. The generalized version you've already read gives you some idea how, but the description isn't complete. Certain points were overlooked in the interest of simplification.

First of all, there is something to remember that will eliminate confusion about the phase relationships in these circuits: The phase relationship between the voice signal and the rf signal is irrelevant; it has no bearing whatever on what comes out of either modulator or out of the whole exciter system. What is important is the phase relationship between the two **audio** components when they are fed to the two balanced modulators, and the phase relationship between the two **rf** signals when they are likewise fed to the modulators. If you make the mistake of trying to visualize any phase relationship **between** the voice signal and the rf, the whole

concept becomes very confusing. Even when the system is explained by vectors, a vector diagram can represent only one particular instant in time; at that instant, the audio signal could be at any particular point of any excursion and so could the rf signal. Consequently, I repeat: ignore any phase relationship between the rf signal and voice signal; *there just isn't any that matters.*

However, to understand the cancelation of sidebands, you do have to consider the phase

fig. 2. Principle of single-sideband generation using phase shifts. With a 90° phase shift to only the rf signal, the combinations from the balanced modulators does not produce a ssb signal. A 90° phase lag in both the rf and audio signals produces an upper-sideband, suppressed-carrier signal (B).

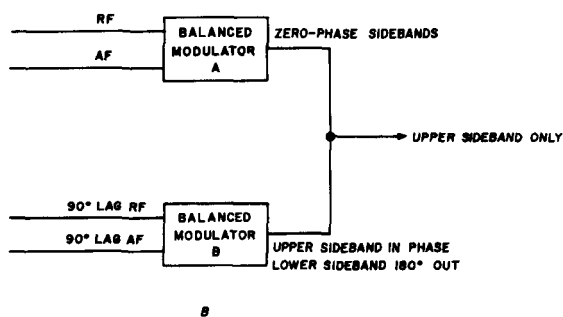
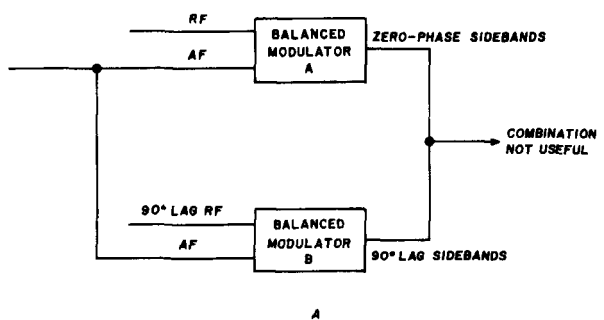

relationship of the **combined** rf-af signal. In other words, even though we don't care about the exact phase of the af in relation to the rf, once they are mixed together, the phase relationships in the signals that result are the basis for the entire explanation. Once having entered the balanced modulators, the rf and af form double-sideband signals. From that

point on, they must be considered as one; they are not rf and af any longer, but are double-sideband suppressed-carrier signals.

Bearing in mind these precautions, you can now consider first what happens in balanced modulator A (fig. 2A). An rf signal is fed in, and so is an af (voice) signal. What comes out of balanced modulator A is a double-sideband carrier-less signal. In all phase relationships there must be some reference point. You can consider the rf going into modulator A as being the zero-phase reference for the **input rf**, and the af going into modulator A as being the zero-phase for the **input af**. It follows, then, that you can also consider the sidebands that come out of balanced modulator A as being at zero phase. Remember that this last reference is necessary because you are going to consider this signal in relationship to the one coming from modulator B.

Next, consider what goes on inside balanced modulator B (still following the action in fig. 2B). Both signals going into modulator B lag those in modulator A by 90° . Remember this 90° lag applies only as the rf and af signals go in. Because the rf and af signals fed into modulator B have this special phase relationship to the signals fed into modulator A, the sidebands that come out of B have a specific phase relationship to those coming out of A.

Without resorting to vector diagrams, what happens in the two balanced modulators can best be explained in terms of results. Considering the input rf as a temporary phase reference, the output of any balanced modulator is a double-sideband signal in which the phase of the sidebands depends on the audio signal. This may be a little hard to understand in view of the mention already made that the phase relationship between input rf and input af is irrelevant. However, keep in mind that you are dealing with **two** balanced modulators, and it is the phase relationships between signals in the two that are important.

Start by analyzing operation under the signal conditions in fig. 2A. At any given instant, balanced modulator A produces two sidebands, an upper and a lower, that you can think of as bearing some arbitrary relationship to the input carrier signal. At the same instant, balanced modulator B produces

two sidebands, an upper and a lower, that bear **the same** relationship to its input carrier signal. However, the input carrier signal at B **lags** that at A by 90° , and therefore the upper and lower sidebands from B also lag the upper and lower sidebands from A by 90° .

That's simple enough, but it doesn't accomplish anything useful. The important action takes place when another change is made in the input signal conditions, and **fig. 2B** shows that change. A 90° phase lag is introduced into the **af** signal going to modulator B. The effect on the sideband signals from modulator B is to swing them even further out of phase with the sidebands from A.

This new phase relationship between the output sidebands is one that is useful. The phase of the upper sideband from modulator B is shifted 90° **backward** from the position it held under **fig. 2A** conditions, and it is back in phase with the upper sideband from modulator A. The phase of the lower sideband at the same time is shifted 90° **forward** from its position described earlier, and it is now 180° out of phase with the sideband from modulator A. The result: a single-sideband output, which is what we want. The lower sideband is canceled, and only the upper appears in the combined output of the two balanced modulators.

The manner in which a single lower sideband is generated is diagramed in **fig. 3**. Starting with the signal conditions in **fig. 3A**, the action follows the lines already explained for producing an upper sideband. The chief difference is that the rf signal applied to modulator B **leads** that in modulator A by 90° . The output, then, so long as the af signal applied to both modulators is the same, consists of two double-sideband signals in which the one from B leads that from A by 90° . Again, this serves no useful purpose.

When the af signal fed to modulator B is shifted to lag that fed to A by 90° , a whole new relationship is set up in the sidebands coming out of modulator B. **Fig. 3B** depicts this set of signal conditions. The upper and lower sidebands from B are affected the same way they were in **fig. 2B**. The phase of the upper sideband is shifted backward 90° from the position it held under **fig. 3A** conditions, and the lower sideband is shifted forward 90° .

Remember, however, that the rf signal reaching B now **leads** the rf signal in A instead of lagging. Shifting the modulator-B lower-sideband phase **forward** puts it in phase with the modulator-A lower sideband, and they reinforce each other. The result: only the lower sideband appears in the combined output of the two balanced modulators.

In summary of the overall effect, balanced modulator B shifts one sideband or the other 180° from the reference or zero-phase sidebands coming from balanced modulator A. Which sideband comes out 180° out of phase

fig. 3. Generating a lower-sideband sssb signal with the phase-shift system. The method shown in A does not provide a useful combination; the audio and rf signals must be phase shifted as shown in B to obtain a lower-sideband suppressed-carrier signal.

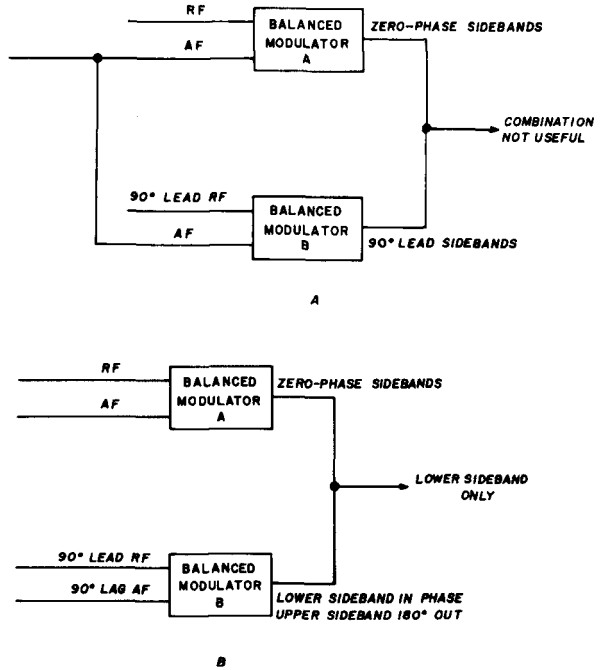

depends on whether modulator B's input rf signal leads or lags by 90° .

sideband switching

Examine that statement a little further. In the one case, the rf signal in modulator B lags by 90° ; in the other, it leads by 90° . The two conditions are 180° apart. Switching

the rf signal in modulator B by 180°, which is the same as exactly reversing its phase, also exactly reverses which sideband is canceled in the combined output.

The two conditions suggest a means by which a phase-shift ssb transmitter can be switched from upper-sideband to lower-sideband operation. Rather sophisticated rf phase-shift networks are switched into and out of the circuit leading to modulator B, to institute whichever phase shift is needed for the mode desired.

Another interesting method of switching sidebands is shown in **fig. 4**. Keep in mind

Fig. 4 also shows the alternative way mentioned earlier of handling the audio phase shift. Instead of one network that must shift the broad range of voice frequencies the entire 90°, two are used—each shifting one portion of the signal 45°. One causes the signal to lead 45°, the other makes it lag 45°; the resulting two outputs are 90° apart. A flatter response characteristic is possible in the networks when this method of phase-shifting is used.

adjusting phase-shift ssb

Proper adjustment of this kind of ssb gener-

fig. 4. Switching sidebands in a phase-shift ssb generator. With the switch in the position shown, the output is a lower-sideband, suppressed carrier signal. For upper sideband, the rf phase-shift network is switched from balanced modulator A to balanced modulator B. The 45° audio phase-shift networks are discussed in the text.

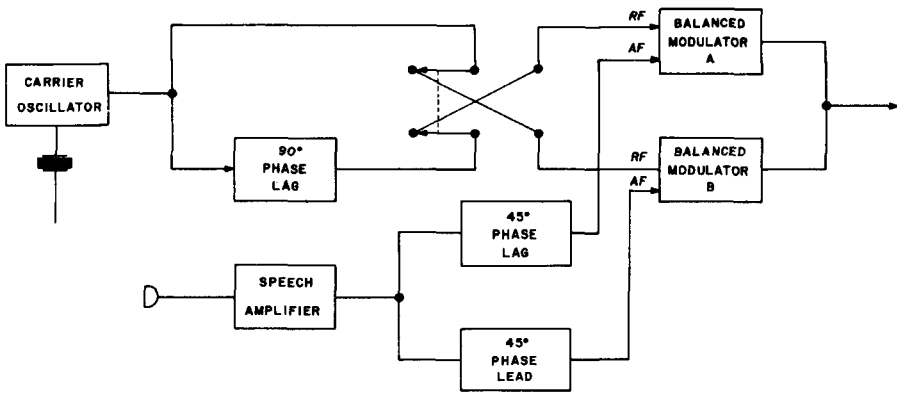

that phase is always a matter of reference. If the rf signal at modulator B lags that at modulator A, it is just as true to say that the rf signal at modulator A leads that at modulator B. It's just another way of stating the same condition. In **fig. 4**, the 90° lag network can be switched from the input of modulator B to the input of modulator A. When the phase-shift circuit is between the rf source and modulator B, the system produces an upper sideband, as has already been described. Move the circuit between the rf source and modulator A, and conditions are right for producing only the lower sideband. That occurs when the rf signal in modulator B leads that in modulator A, and it doesn't matter if the relationship is caused by lagging rf signal to A.

ator is a matter of care and the right test equipment. There are several techniques, but the simplest—using an oscilloscope—will be covered here; it is adequate for all except the most exacting conditions.

Two things are to be accomplished by alignment. First, the two balanced modulators must be adjusted individually for zero carrier output, with no voice signals applied. Second, the overall stage must be adjusted for maximum suppression of the unwanted sideband.

Obtaining the first requirement is the easiest. An rf indicator near the output of the exciter will let you know when each balanced modulator is adjusted for minimum carrier output. The controls to adjust are the "rf balance" or "carrier balance" adjustments; since

there are two balanced modulators, there will probably be two such controls. Each balanced modulator may also have a "phase" adjustment—often a trimmer. Adjust each of them for minimum carrier output. You may have to juggle a little between the "balance" and "phase" adjustments of each modulator to find which position results in the least carrier output.

For the sideband-suppression adjustments, you must connect the scope to indicate the output signal from the ssb exciter. A pickup loop coupled loosely to the exciter and fed directly to the vertical deflection plates of the scope will usually work out fine. Tighten or loosen the coupling of the loop to get a usable display on the scope screen. The internal sweep of the scope should be set for any convenient submultiple of the test tone that is to be used to modulate the ssb exciter. If 1000 Hz is to be used, set the scope for 50 or 100 Hz, so you can see several ripples if any ripples exist.

The af test signal is from an audio generator, fed to the speech input connection of the exciter. Be sure to use as little signal as will modulate the exciter; too much will create distortion that can make adjustments misleading. The frequency to use depends on the phase-shift network used in the exciter, but 1000 or 1200 Hz will work out about right in any case.

What you are trying for is a pure sideband output, indicated on the scope by a smooth "bar" of rf, an inch or two high on the screen (its exact height is determined by how tightly the pickup loop is coupled to the exciter). The sign of incorrect sideband suppression is a ripple along the top and bottom of the rf envelope or "bar." The deeper the ripple, the poorer the sideband suppression. The ripple is caused by beat components generated when two sidebands mix with each other. Adjustments, therefore, are made to reduce any ripple that is visible.

There are certain requisites in the circuit for maximum suppression of the unwanted sideband. One is that the rf signals fed to the two balanced modulators be precisely 90° apart—no more, no less. The signals should be approximately equal in amplitude, but the 90° phase separation **must** be exact. There-

fore, an "rf phase" control is provided, sometimes two. (The two doesn't mean one for each modulator, but represents a particular type of phase-shift network that may be used.)

A second important requisite for perfect sideband suppression is that the af signals fed to both balanced modulators be exactly the same amplitude. An "af balance" control takes care of that. In a few exciters, there is also an "af phase" control; but phase isn't as critical in the af signals as the amplitude match, so most transmitters keep af phase balanced by fixed resistors.

Setting these two (or three) controls is all there is to aligning the exciter for proper sideband suppression. You watch the pattern on the scope, and adjust first the rf phase and then the af balance until there is as little ripple as possible in the pattern. Once the adjustments have been made, it is well to go back and check the carrier-balance controls in each balanced modulator. Touch them up, then touch up the sideband-suppression adjustments.

Once ripple has been reduced to a minimum, switch to the other sideband. Best adjustment for one may not be best for the other. If there is any ripple on the other sideband, it probably can be reduced by readjusting the rf phase control. You may have to leave it set halfway between the first setting and the last, as a compromise to both sidebands.

With careful adjustment, using proper techniques and equipment, phase-shift single-side-band generation can be almost as effective as filter-type. The scope method of adjustment just described is good enough for a dependable 30 dB of sideband suppression. More than that is possible with more sophisticated adjustment procedures.

In the vhf and uhf bands, you may see phase-shift sideband generators used more often—since ssb has caught on. Better equipment and better techniques will probably make this equipment more popular. What you've learned here will help you make optimum use of this truly convenient principle.

reference

1. F. H. Belt; "Generating SSB Signals with Suppressed Carriers," *ham radio*, May, 1968, p. 24.

ham radio

GOING STRONG!



The latest evolutionary development of the Classic Model 350

The new SWAN 350-C *5 band, 520 Watt* *SSB-AM-CW TRANSCEIVER*

The introduction of the new model 350-C at no increase in price over the popular 350 is a real triumph of value engineering.

Power rating of the 350-C is the same as the Deluxe Model 500-C, which is 520 watts P.E.P. input on single sideband, 360 watts CW input, 125 watts AM input. A pair of rugged, blast-rated 6LQ6 tubes handle this input with ease. Selectivity is provided by the same superb crystal lattice filter used in the 500-C, with skirt selectivity and ultimate rejection superior to any other filter being used in amateur equipment today. Audio quality has the same degree of fidelity which Swan has stressed from the very first single band transceivers.

The 350-C is designed to operate automatically on the normally used sideband with extended frequency coverage of all five bands, 10 through 80 meters. The high frequency crystal lattice filter is common to

transmit and receive circuits. Bandwidth is 2.7 KC. Audio bandpass is essentially flat from 300 to 3000 cycles. Sideband suppression is greater than 50 db; carrier suppression is greater than 60 db. Grid block CW Keying is provided with offset frequency. The VFO is transistorized, temperature and voltage stabilized. Receiver sensitivity is better than $.5 \mu\text{v}$ for 10 db signal-plus noise to noise ratio. Velvet smooth dual-ratio tuning is featured, as in all Swan Transceivers. Basically the difference between the 350-C and the 500-C is in the deletion of optional features which are not essential to communication. These include such things as crystal calibration, sideband selector, CW sidetone, automatic noise limiter, automatic level control, etc. For the operator who desires these features, we are proud to recommend the deluxe model 500-C. However for powerful and reliable communications without all extras, we now offer the new 350-C, and we are confident that you will rate it a truly exceptional value. **\$420**

ACCESSORIES

117XC Matching AC supply with speaker.....\$105
14-117 12VDC Mobile Supply.....\$130

VISIT YOUR SWAN DEALER SOON

SWAN SPEAKS YOUR LANGUAGE
ASK THE HAM WHO OWNS ONE



SWAN

ELECTRONICS
Oceanside, California
A SUBSIDIARY OF CUBIC CORP.

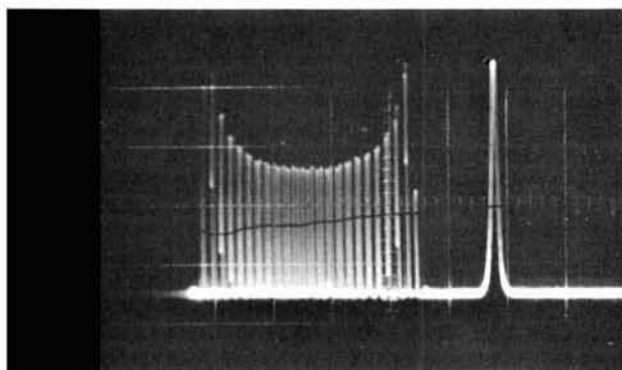

This is the way the output from a sweep generator looks on a spectrum analyzer. The "pip" on the right-hand side is a marker signal.

instrumentation and the ham

You may not have access to some of the instruments described in this article, but it should give you an idea of some of the things that can be accomplished with modern equipment

M. J. Goldstein, VE3GFN, 22 Kingswood Road, Toronto, 13, Ontario, Canada

It has been my lot in life, over the past eight years, to be closely associated with much of the better electronic measuring equipment—mostly with research and development labs and lately in the educational field. Needless to say, having access to such equipment has been a great benefit to my ham career since homebrewing is my greatest passion. It occurred to me, after several months of instructing engineering students in the use of instruments, that if graduating engineers find instrumentation a mystery, certainly Joe Ham could be in the same boat.

To the majority of hams who have no access to fine instruments, a discussion of this nature may provide an insight into a side of the hobby not previously encountered. Most dedicated homebrew artists seem to come up with any instruments they need, but you may find a new attack to some old problem in this article.

I would like to mention that the objective here is not to teach you how to use any instrument; only careful study of the instrument with the manual can accomplish this. Rather, it is to demonstrate what can be accomplished in a properly-equipped lab, and how measurements familiar to the ham world are obtained. While some of the equipment mentioned may appear to dwell

in the science-fiction region, please be assured that all of it exists.

filters

A common problem in ham gear is obtaining the response characteristics of filters, whether they're used in exciters, receivers or

fig. 1. Test setup for measuring the response of a typical RTTY filter is shown in A; a plot of the measured characteristic is shown in B.

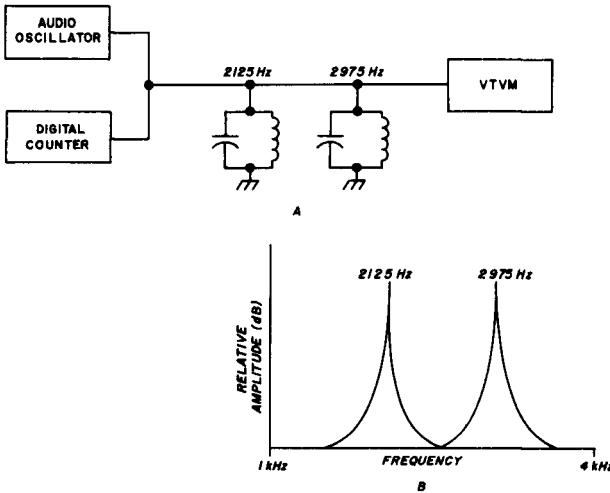

what-have-you. Let's examine the several ways of measuring this response.

Suppose you have an RTTY converter which includes a filter that rejects all but 2125 and 2975 Hz. A popular system is to use two parallel hi-Q tuned circuits employing toroidal coils. An equipment set-up that can be used to measure the response of such a filter is shown in fig. 1.

The digital counter indicates the oscillator

frequency directly in frequency units with great accuracy, constantly sampling the frequency and indicating any change. The audio VTVM has a decibel scale and will indicate audio levels down to sixty decibels below one volt. The frequency limits of the VTVM depend on its quality, but most will respond accurately to the frequencies we are discussing here. Most response curves are plotted as amplitude levels in decibels, and the convenience of having an indicating device calibrated in these units is apparent. If such a VTVM is not available, a standard VTVM can be used; the level changes can be converted to decibel changes by using the nomograph in fig. 3. This chart is based on the formula:

$$\text{dB} = 20 \log_{10} \frac{\text{large voltage}}{\text{small voltage}}$$

The measurement procedure is as follows: set the oscillator frequency well below the lower filter frequency, and set the output level at one volt before the filter is connected in the circuit. Connect the filter. Move the frequency up the spectrum in 100-Hz steps, noting the relative level at the filter output at each frequency. Take readings at smaller frequency increments as the critical frequencies of the filter are approached to obtain an accurate response. Continue this procedure until you're well above the upper filter frequency. The correct form of the response characteristic, as it would appear when plotted on semi-log graph paper, is illustrated in fig. 1.

On the other hand, assume we have a mechanical filter with a center frequency of 455 kHz and bandwidth of 3 kHz. Another method of measuring a filter response is shown in fig. 2. The only precautions to be observed for this measurement are to shield the filter input from the output, and ensure

fig. 2. Another way of measuring the frequency response of a filter. The plotted output is shown in B.

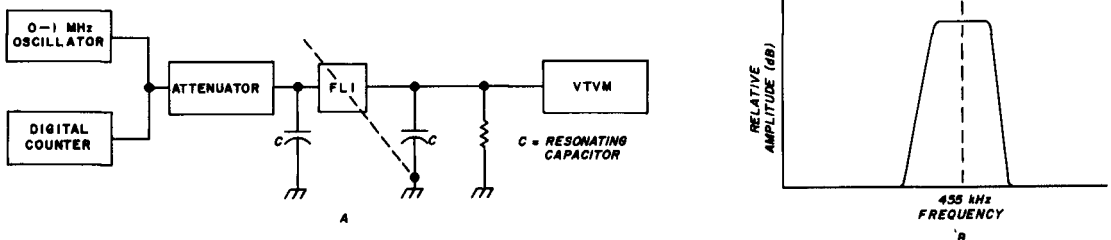

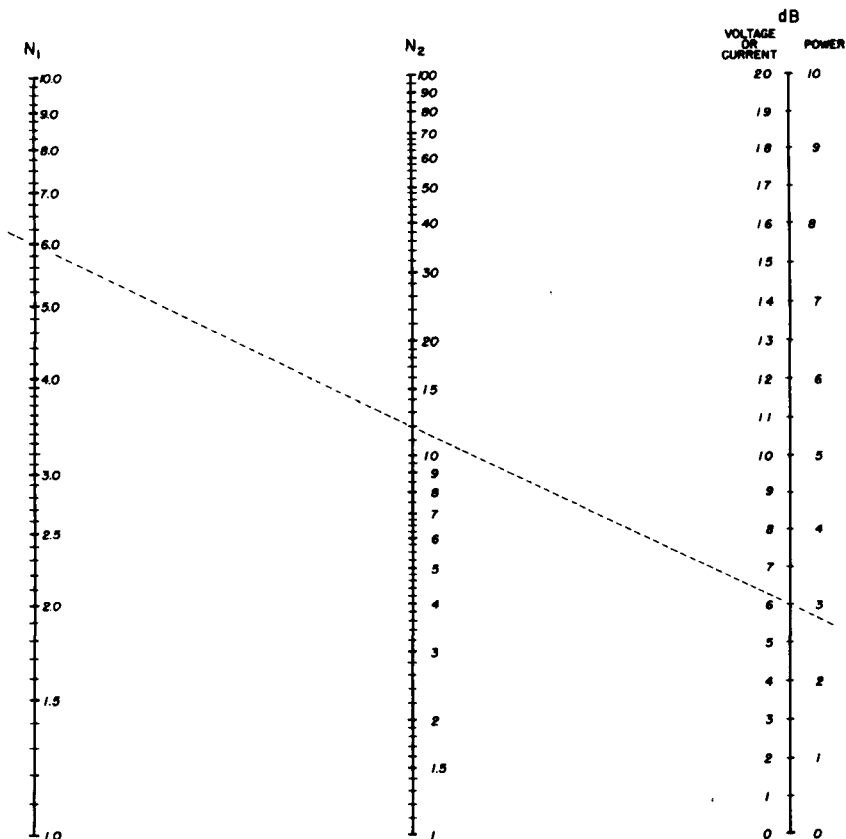

fig. 3. Nomograph for converting voltage, current and power ratios into dB, either gain or loss. The larger number is entered on the N2 scale; the smaller number on N1. A straight line connecting these two points is extended through the dB scale—the point of intersection is the answer in dB. If for example, the voltage into an amplifier is 6 volts and the output is 12 volts, what is the gain of the stage? The answer is 6 dB as indicated by the plotted line. Or, if you put 12 watts into one end of a transmission line and measure 6 watts out, what is the loss of the line? The answer is 3 dB as indicated on the power side of the dB scale.

the VTVM will respond accurately to 500 kHz.

The procedure is as follows: adjust the oscillator output to exactly five volts (before the attenuator). Set the attenuator to 0 dB. Sweep the oscillator frequency around 455 kHz until the VTVM indicates a peak. With this filter, the peak will be about 2-kHz wide, so adjust the frequency for the middle of the peak. The peak level should be some decibels below the five volt level, depending on the filter. Insertion loss is the decrease in gain that the filter will cause when put in a circuit. The oscillator output is set to a high level so you can measure very low attenuation levels at the filter output without running out of VTVM sensitivity.

Once the peak frequency has been adjust-

ed, turn the oscillator output level to minimum. Adjust the attenuator for maximum attenuation (should be at least 60 dB). Set the VTVM to the most sensitive scale (-60 dB), and adjust the oscillator output level until

fig. 4. Measuring filter response with a spectrum analyzer.

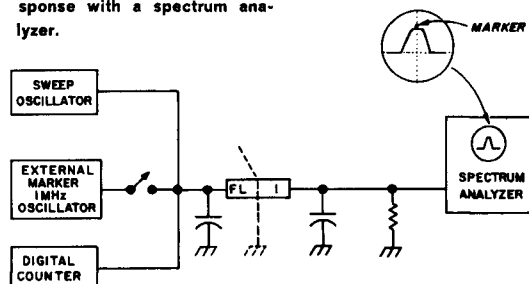

the VTVM indicates "0 dB" on this scale. Remove one-half dB of attenuation, and adjust the oscillator frequency below the peak frequency until the VTVM again indicates 0 dB. Note the frequency. Continue in half-dB steps until 3-dB of attenuation have been removed. Proceed in 1-dB steps until 10 dB of attenuation have been removed. Continue in 5- or 10-dB steps until the remaining attenuation has been removed.

Now, set the oscillator to the peak frequen-

fig. 5. Checking the output of a sideband generator with a spectrum analyzer.

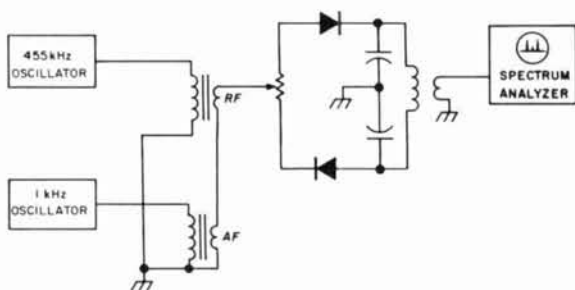

cy as before, and repeat the procedure on the high side of the peak frequency.

The same filter response can be examined, without plotting it by hand, by using some of the latest oscilloscope techniques. You can use a spectrum analyzer, which may take the form of a complete unit, or perhaps as a plug-in unit for a standard scope frame. The hookup is illustrated in **fig. 4**. The sweep oscillator is an oscillator which sweeps back and forth over a pre-adjusted band of frequencies. The horizontal axis of the spectrum analyzer can be adjusted to display the same band of frequencies; the vertical axis is calibrated in volts. Once the filter response is set up for display on the analyzer, a separate oscillator can be connected to the sweep oscillator as a "marker" oscillator. A pip will appear on the displayed response when the marker oscillator frequency is within the frequency band under display. The marker oscillator can be switched to drive the frequency counter so a method of accurately calibrating the horizontal axis of the analyzer is available.

sideband generators

The major problems of designing a filter-type sideband generator are balancing the balanced modulator (a problem also encountered in phasing exciters) and setting the frequencies of the carrier crystals at the proper point on the response curve of the filter.

Fig. 5 shows a balanced modulator driving the spectrum analyzer. The 455-kHz oscillator simulates one of the two carrier crystals you will ultimately use. The 1-kHz oscillator simulates the microphone input signal.

Theory states that the output of the balanced modulator should appear as in **fig. 6**.

fig. 6. Spectrum analyzer display of the output from the test setup shown in fig. 5.

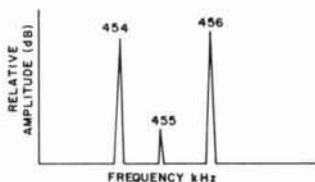

This is the response which should appear on the face of the spectrum analyzer. The balanced modulator is properly adjusted when the carrier pip at 455 kHz is at minimum amplitude. You made the necessary measurements to set the frequency when you accurately measured filter response. The carrier crystals should be 1500 Hz above and below the "peak" frequency of the filter.

Characteristic curves of a 2N410 transistor as displayed on a curve tracer.

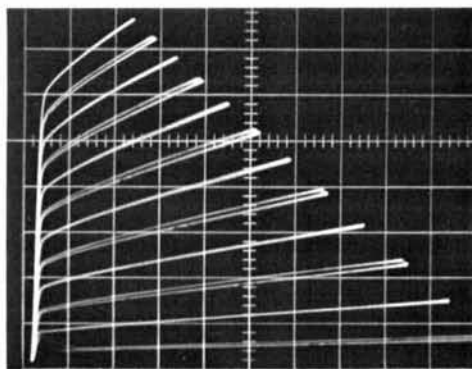

transmitters

All of the adjustments and measurements to be made on a transmitter can be made with a wide-band oscilloscope, several of which are now on the market. You can examine the sine-wave output of your two-meter transmitter, adjust your keying characteristic's rise and fall times within nano-seconds, and trace non-linearities in ssb rigs from the audio input to the 30-MHz output. You can measure the frequency of parasitics, and neutralize your final to within an inch of its life (does anyone neutralize anymore?). You can adjust each coupling circuit for absolute maximum coupling or optimum coupling, which is more realistic, and measure output power in PEP to the nearest milliwatt.

fig. 7. Measuring the frequency drift of a communications receiver.

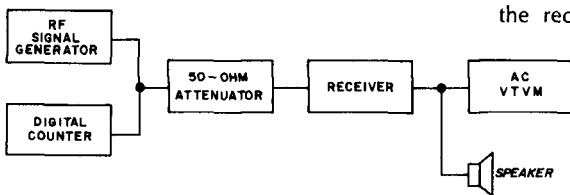

receivers

There are a multitude of measurements that can be made on a receiver to determine whether or not optimum performance is being obtained. Frequency stability is one. The simplest method of evaluating the stability of a receiver is to measure the stability of the variable oscillator over a period of time—preferably the warmup period of the receiver. This is done by connecting a digital frequency counter to the variable oscillator output and measuring the frequency difference in the time between turn-on and, say, two hours of warmup. The frequency difference can be read to the nearest cycle. A more realistic approach where the drift of the entire receiving system is involved is illustrated in fig. 7.

Since the ultimate purpose of a receiver is to make measurements by ear, it's quite "cricket" to use the speaker as an output device. The purist can use the VTVM to make

absolute measurements of audio level. The attenuator is provided to decrease the relatively high output level of most signals to a level suitable for making measurements on a sensitive receiver.

Allow the instruments to warm up for at least several hours. The BFO on the receiver is turned on; the receiver is tuned to the frequency of the generator, then turned on. It is adjusted immediately for "zero-beat," as indicated by minimum audio level in speaker and VTVM. Note the indicated frequency of the signal generator. At time increments of ten minutes, re-adjust the generator for zero-beat, noting the new frequency each time, until all indications of drift cease. This drift characteristic can be plotted on semi-log graph paper, as shown in fig. 8.

The mechanical stability of the receiver can be examined using the same setup. Adjust the system for zero-beat as before. Give the receiver a hearty thump, and measure

fig. 8. Typical frequency-drift characteristics of a communications receiver using the test setup shown in fig. 7.

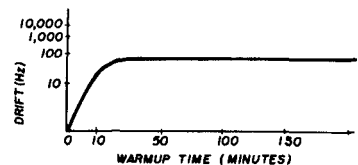

any frequency change. Be sure that the frequency controls on the receiver are not moved while you're thumping it.

receiver tracking

The tracking of the receiver's tuned circuits can be easily checked over any desired frequency range by using the test setup of fig. 7. The VTVM is not used, and an audio power meter should be connected across the speaker terminals and set to the correct impedance. Adjust the signal generator to the lowest frequency in the desired range. Peak all tuned-circuit controls. Adjust the audio gain and BFO control for a convenient indication on the power meter.

From this point on, adjust only the rf tuned circuits. Adjust the frequency of the generator in convenient steps through the range of the receiver, peaking the tuned circuits each time for maximum indication on the power meter. Note the frequency and output power level each time the frequency is changed. The tracking characteristic can be plotted on linear graph paper as shown in **fig. 9**. Perfect tracking would yield a straight horizontal line on the plot.

If the tracking characteristic is undesirably shaped, it can be corrected by readjusting the receiver front-end while the receiver is connected as shown in **fig. 10**. The time-mark generator is a device commonly used for calibrating oscilloscope time-bases. It provides marker pulses of short duration at selectable time intervals. With one micro-

fig. 9. Plot of receiver tracking characteristics over the range from 10 to 30 MHz.

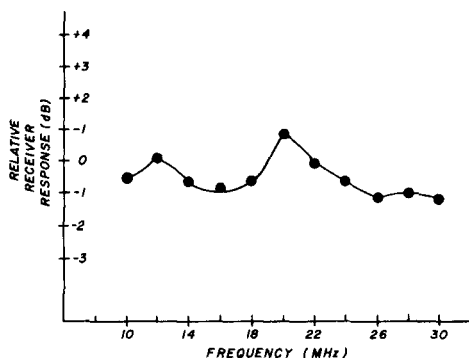

second markers, you have 1-MHz markers, since $\text{frequency} = 1/\text{time}$. Therefore, the time-mark generator may be used to provide frequency calibrations across the face of the spectrum analyzer. The spectrum analyzer is connected across the output of the last mixer, and provides a constant display of the tracking characteristic, making it very easy to observe the overall effect of any tuned-circuit adjustments.

adjusted balanced mixers

Many of the latest receivers use balanced mixers. These must be balanced for ac and

dc to optimize their performance. This is most easily done with an oscilloscope having a differential input.

For a dc balance, the two scope inputs are first grounded, the inputs switched to "dc,"

fig. 10. Using a spectrum analyzer to adjust the tracking of a communications receiver.

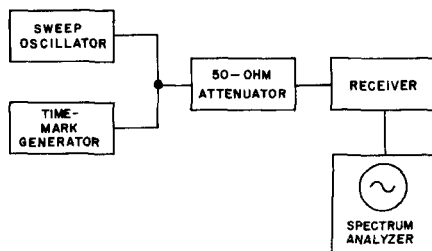

and a zero reference obtained. The scope inputs are then connected to the two mixer inputs which require balancing. The oscilloscope will indicate any **difference** in dc potential between the two mixer inputs. The dc balance control on the mixer is adjusted for minimum dc potential difference. The ac balance is obtained by switching the scope inputs to ac, and repeating the procedure using the ac balance adjustments to minimize the amplitude of the waveform displayed on the oscilloscope. This waveform will most likely be a sine wave with amplitude proportional to the degree of ac unbalance of the mixer.

summary

There are a host of other measurements to be made on ham gear, but the ones mentioned here seem to be the most interesting. One of the nice ways to keep measurement records of oscilloscope traces is by means of Polaroid photographs, made with special cameras designed for that purpose. Some sample pictures have been included to show the versatility of this technique.

From the loop-and-bulb to the spectrum analyzer is quite a jump, but progress is what makes this old hobby of ours the fascination it is. Now where did I put that coffee-can grid-dipper . . .

ham radio

which way does current flow?

Positive to negative,
negative to positive,
or does it really
make any difference?

Strongly held expert opinion that current flows from plus to minus sharply opposes strongly held expert opinion that current flows from minus to plus. This situation has existed for many years. It complicates discussions between experienced workers in electronics, and has a specially confusing effect upon beginners and students.

Why have these apparently contradictory opinions persisted? The answer lies in the history of electronics and physics. As with many differences that are hard to settle, this is a matter of words. Both views work if applied **consistently** with slightly different meanings of key terms; and there is a good chance that both views are wrong!

The key terms are **current** and **charge**. Correct usage, having roots in history and physics, is that current is a rate of flow of charge. The latter usage, found in many electronics texts, is that current flows from plus to minus (or minus to plus) without any mention of charge. The plus-minusers point to history to support their view, and the minus-plussers point to electrons. If you can stand that word once more, both have missed the point.

the answer is in physics

It is surprising to look back in history and discover a time, not so very long ago, when there was no field of electronics. We must look back much farther to find a time when there was no physics, but maybe the line can be drawn at Galileo. He introduced the idea, regarded as revolutionary in his time, of comparing the results of careful thinking with the results of careful experiments and changing the thinking if the experiments

Jim Ashe, W2DXH, 301 Dryden Road, Ithaca, New York 14850

didn't agree. Previous technique was to ignore the experiment—if somebody happened to perform it.

As the science of physics developed, workers noticed and studied electrical effects, and came to understand something of what was actually happening. Ben Franklin introduced the terms positive and negative in 1747, and in the 1800's the first spin-offs from physics began to appear: telegraphy, power transmission and lighting. As work continued, new spin-offs appeared; some of them became the electronics we are familiar with today.

The close association between electronics and physics continues, and all of the electrical quantities in electronics are the same as or based upon the units of measurement used in physics. A physicist can provide the expert opinion required to understand the "current" problem.

When asked which way a current flows, he is likely to say, "Current is a scalar quantity. It is a magnitude, a meter reading. It has no direction. And since a current is a flow of charge, the common expression, 'flow of

fig. 1. Two fixed charges, and two induced charges. Description of this arrangement is greatly simplified by the physics convention that the electric field at any point has the strength and direction experienced by a 1 coulomb positive test charge placed at that point in the field.

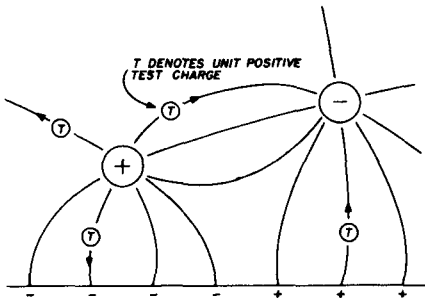

current,' should be avoided. That means, literally, 'flow of flow of charge,' not very good English. But 'flow of charge' is perfectly correct usage, and not at all ambiguous as to direction. Charge flows from plus to minus."

Well, that is a bundle of news and no mistake! Let's take this a bit at a time. Why

does charge flow from plus to minus? Because everybody in physics agrees that it does: a convenience worked out before 1800 and used ever since. It is based upon a standard procedure for investigating and describing electrostatic fields. It is the same kind of notion as the modern equivalent circuit, Thevenin generator or Maxwell loop current:

fig. 2. Placing the positive test charge in a wire, we find it wants to move toward the negative battery terminal, against the flow of electrons.

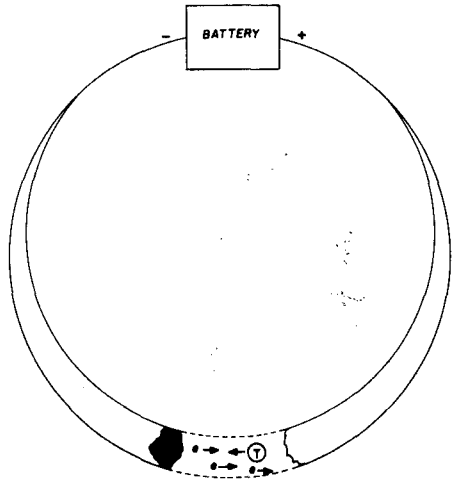

it is a conceptual handle.

Careful tests by Coulomb in 1785 clarified the importance of having a basic quantity of charge, and once the notions of quantity and direction were worked out, people could start talking about electricity in a meaningful way. The terminology and concepts were well worked out when the electron was discovered in 1895 by Thompson, and named by the Irish physicist Johnstone Stoney. It turned out that electrons were negative, so, consequently, they passed from minus to plus; but people described the situation as transferring a charge from plus to minus. The great controversy was all set up—it continues to this day.

modern conventions

It's likely that the controversy will continue indefinitely. However, for situations where

careful thinking and description are required, the conventions in physics are easy to use and surprisingly like some common experience with automobiles. The basic concepts are those of **field**, **charge** and **flow of charge**, or **current**.

If there is a fixed electrical field, there must be a charge or charges somewhere that produces it. The size and location of these fixed charges is often unimportant. Few electronics experimenters are interested, for example, in the exact electrical fields and electrodes inside a transistor.

Of more concern is the amount and motion of movable charges affected by the fields. Charges are commonly specified in terms of coulombs, a very definite amount of electricity. One coulomb will plate about 1.1 milligrams of silver from a standard bath, exert a 1-newton force on an equal charge 1 meter away, fill a 1-farad capacitor to 1 volt, or meet some other standard definition.

When coulombs are under motion, a charge flows, and we say there is a current. The current in amperes is the rate of flow past a point or through a surface in coulombs per second. An ampere-second is 1 coulomb,

but it's probably best to leave the details to the physicists and think of coulombs as ampere-seconds.

This entire picture has a very close analogy in cars and traffic. The mile, as a unit of distance, corresponds to the coulomb, the unit of charge. The speedometer, indicating miles per hour, is like the ammeter, indicating coulombs per second. The physicist knows that a charge can travel in any direction, but is most conveniently moved along wires; the driver knows he can drive in any direction, but most conveniently along roads. The ammeter doesn't know the difference, nor does the speedometer. The similarity would be even closer if cars didn't have engines and had to roll downhill. Then we would label the hilltops plus, and the valleys minus, and call the geographical terrain a **field**.

We see the 'flow of current' term used every day, and it works. You may as well continue to use whatever you're accustomed to. But if you find yourself in a deep discussion, or if you need to be specifically clear in your thinking, try using the conventions used by the physicists.

ham radio

■ transformer shorts

Transformer shorts occur in many ways. They can be caused by moisture absorption, hygroscopic leakage on the insulators, damp cotton-covered output wires, overload, poor or old paper insulation, just to name a few. The phenomena of a shorted transformer can be very puzzling because the line fuse will blow when nothing seems to be wrong, especially when the transformer has been disconnected from the power supply.

Here is the way some of the old timers check a transformer. First, disconnect the secondary winding leads. Next, put an ordinary 50- to 100-watt light bulb in series with the primary winding. If the transformer is good, the lamp will glow dimly when it is plugged into the 120 volt ac line because of the resistance of the winding. If the transformer has a shorted turn, the lamp will burn brightly. This will also happen if there is a short in either

the primary or secondary winding.

You can prove this to yourself by shorting the secondary winding with a clip lead; the lamp will burn brighter. Unless you tie the clip leads to a long stick however, this exper-

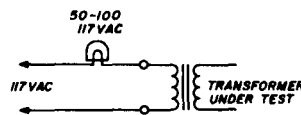

iment should only be used with low-voltage transformers. Pull the line cord while shorting, and keep your hands off while the power is on—we don't want you at the bottom of a hole. High-voltage ac has a propensity of going through insulation to your fingers, so please, put the clip leads on a long stick!

Ed Marriner, W6BLZ

2 METER SINGLE SIDEBAND

144-148 mc 240 WATTS P.E.P. INPUT

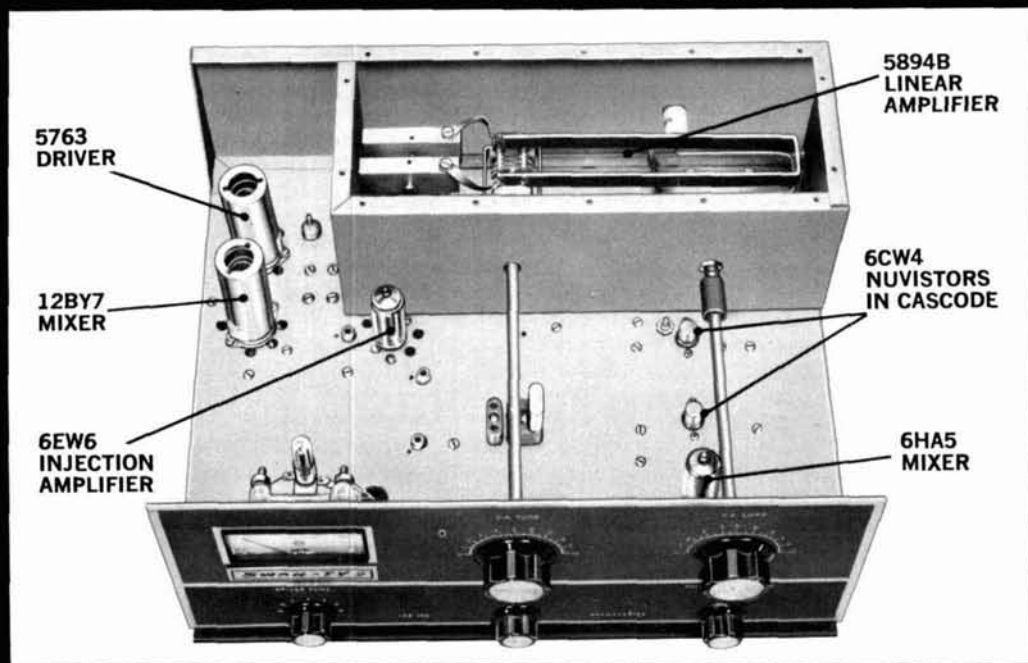

THE NEW SWAN TV-2 TRANSVERTER

A receiving and transmitting converter for the 2 meter band, designed to operate with Swan Transceivers, models 250, 350, 350-C, 400, 500, and 500C.

SPECIFICATIONS:

14 mc intermediate frequency is standard. Thus, when operating the Transceiver from 14 to 14.5 mc, the Transverter functions from 144 to 144.5 mc. Additional crystals may be purchased and switched in for other portions of the 2 meter band, such as 144.5-145, and 145 to 145.5 mc. Three crystal positions are available.

Alternately, the TV-2 Transverter may be ordered for an I.F. in the 21, 28 or 50 mc bands, if desired. Of course, for use with a Swan 250 six meter transceiver, the Transverter must be ordered for 50 mc. Otherwise, the standard 14 mc I.F. is recommended since bandwidth and frequency read-out will then be optimum. The Transverter can easily be adjusted in the field for a different I.F. range, if required.

A 5894 B Power Amplifier provides a PEP input rating of 240 watts with voice modulation. CW input rating is 180 watts, and AM input is 75 watts.

Receiver noise figure is better than 3 db, provided by a pair of 6CW4 nuvistors in cascode.

Only a Swan Transceiver and Swan AC power supply, Model 117-XC, are required. The power supply plugs into the Transverter, and the Transverter in turn plugs into the Transceiver. Internal connections automatically reduce the power input to the Transceiver to the required level.

Tube complement: 5894B Pwr. Amp., 5763 Driver, 12BY7 Transmit Mixer, 2N706 crystal osc., 6EW6 Injection Amp., 6CW4 1st rec. amp., 6CW4 2nd rec. amp. in cascode, 6HA5 rec. mixer.

The Swan TV-2 may also be operated with other transceivers when proper interconnections and voltages are provided. A separate Swan 117-XC power supply will most likely be required.

Dimensions: 13 in. wide, 5½ in. high, by 11 in. deep.
Weight: 13 lbs.

\$265



MODEL 250 \$325
MODEL 350C 420
MODEL 500C 520

MODEL 117-XC
AC POWER SUPPLY .. \$105

MODEL TV-2
144 mc TRANSVERTER



SWAN
ELECTRONICS
Oceanside, California
A SUBSIDIARY OF CUBIC CORP.

july 1968  37

choosing diodes for power supplies

Diode rectifiers have largely replaced tube rectifiers in amateur transmitters. This has reduced transformer size because the rectifier filament winding isn't needed any more. Heat inside the cabinet is also reduced. This is all very good, but you now have to decide what PIV diode you want before doing any construction.

In the old days, all you had to do was reach in the junk box for an 80, a 5R4GY or an 866. Since life is more complicated now, it's handy to keep a diode reference chart on the wall, or at least a diode source book handy.

The circuit shown in **fig. 1** is a full-wave bridge. The maximum peak inverse voltage (PIV) is $1.14 \times E_{rms}$ (the transformer output voltage). Let's assume we have an 850-volt dc transformer (rms). How many diodes will be required in each leg of the bridge? According to the book, the inverse peak voltage will be 1.14×850 . This gives us about 970 peak volts across each leg of the bridge. The diodes in each leg will have a peak-to-peak voltage of 970 volts impressed across them, so it is obvious that one 400-PIV type is not going to do the job. It will take several of them in series plus a safety factor. Actually, a single 1600-PIV or four 400-PIV diodes in series would be a good choice. Let's work this out a little further:

$$E_{dc} \text{ (output dc)} = \frac{E_{rms} - 2NV}{1.11}$$

Where:

N is the number of rectifiers used in each leg of the bridge

V is the voltage drop per rectifier at 80% of the rated load current. (Use a value of 1.5 V)

With these factors in mind, we find that the actual dc output is 755 volts.

The bridge circuit is handy because you can always use the center tap for a low-voltage supply, even though the copper losses go up. In ssb use, the transformer will handle the extra load because power is taken off in pulses.

The diodes should be mounted in an area away from any heat, and use a heatsink to keep the heat from damaging them when you're soldering them into a circuit. If nothing else, hold the leads with long-nose pliers.

Since all of the constants make such a small change, the PIV across each leg of the bridge

fig. 1. Full-wave bridge rectifier circuit.

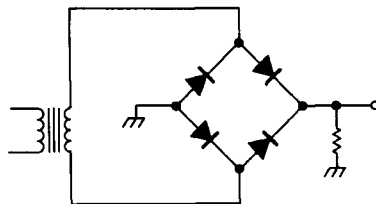

can be used as a starter plus a safety factor for line transients of perhaps 100 volts. Diodes are quite inexpensive, and the higher ratings are not that much more expensive.

The full-wave center-connected circuit in **fig. 2** is figured differently. Here, the peak voltage is 1.414×350 (example) or 494-V

Ed Marriner, W6BLZ, 528 Colima Street, La Jolla, California 92037

table 1. PIV values for full-wave bridge and full-wave, center-tapped rectifier circuits.

transformer (Erms)	full-wave bridge (PIV per leg)	full-wave ct (PIV per leg)
200	283	566
300	424	848
400	565	1132
500	707	1414
600	848	1696
700	990	1980
800	1131	2262
900	1273	2546
1000	1415	2830

peak. If we call it 500 to round it out, then the peak inverse will be -500 plus 500 or 1000 volts stress across each leg. This tells us it would take three 400-PIV diodes plus a little safety factor for each leg—a total of six diodes.

In case you can't remember how to do it next time, table 1 is a handy little chart which shows the peak inverse voltage across each leg of full-wave bridge and full-wave center-

fig. 2. Full-wave, center-tapped rectifier circuit.

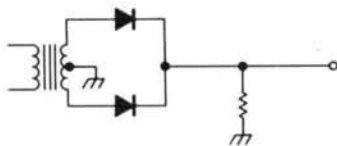

tapped power supply circuits.

Add a safety factor to the values in table 1 when picking a diode. This could be anybody's guess since the amplitude of a transient depends on what part of the cycle it is passed through the transformer. Allow at least 100 volts on small supplies and more on high-voltage types. It's also a good idea to put a transient suppressor across the primary of the power transformer. You can use a commercial device such as a General Electric Thyrector or Sarkes Tarzian Klipvolt or a transient-suppression circuit.¹

references

1. J. Fisk, WIDTY, "Ham Notebook," *ham radio*, July, 1968, p. 75.
2. "Silicon Rectifiers," Published by Sarkes Tarzian, Inc., Bloomington, Indiana, 1960.

ham radio

NOW!

IN THE WEST

Now... 2000 Watts P.E.P.
Full Power/Minimum Size
FOR APARTMENTS • SUBURBAN HOMES
 Marine and Portable Operation
 Packaged for APO and FPO Shipping

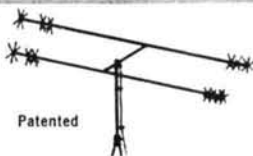

6-10-15-20 METERS

The time proven B-24 4-Band antenna combines maximum efficiency and compact design to provide an excellent antenna where space is a factor. New and loading for maximum radiation efficiency. No center loading.

Bands	6-10-15-20 Meters
Power Rating	2000 Watts P.E.P.
El. Length	11'
Turn. Radius	7"
Total Weight	11 lbs.
Single Feed Line	52 ohm
SWR at Resonance	1.5 to 1.0 max.

Model B-24
Net \$59.95

MULTIBAND COAXIAL ANTENNA for 6-10-15-20 METERS

Needs no ground plane radials. Full electrical $\frac{1}{2}$ wave on each band. Excellent quality construction. Mount with inexpensive TV hardware. Patented.

Power Rating	2000 Watts P.E.P.
Total Weight	5 lbs.
Height	11'
Single Feed Line	52 ohm
SWR at Resonance	1.5 to 1.0 max.

Model C4 Net \$34.95



Free Delivery On
"MINI BEAMS"
From

QUEMENT ELECTRONICS

1000 SOUTH BASCOM AVE.
 SAN JOSE, CALIFORNIA

95128

PHONE 294-0464 SINCE 1933

the dual-channel compressor

This approach
to audio compression
uses a stereo preamp;
one channel for control,
the other for compression

If you have any old audio equipment in a forgotten corner of the shack, you can probably turn it into a very useful piece of gear. In this article I'll show you how to turn a stereo phono preamplifier into a very effective audio compressor for use with a ssb transmitter. The preamplifier was set aside when I bought a new high-fidelity amplifier. I used it briefly as a microphone preamplifier for the transmitter and then it occurred to me that it could be made into a unique type of audio compressor. The same idea could probably be applied to any similar unit you might have. Two separate amplifiers, which by themselves might be considered of limited value, may also be used.

audio compressor circuits

The operation of a conventional audio compressor is shown in **fig. 1A**. Here, the input audio signal passes through two or more stages of audio amplification; part of the audio output of the last stage is rectified to produce a dc control voltage. This control voltage is used to regulate the gain of the first audio stage. It may control a transistor switch to regulate the first-stage supply voltage, or, a diode attenuator. The methods of using the control voltage vary widely, but the principle remains the same.

The preamplifier I use contains two identical low-noise audio channels. I could have used the conventional scheme of audio compression in the second stage of either channel but, instead, I developed the method

John J. Schultz, W2EEY, 40 Rossie Street, Mystic, Connecticut 06355

shown in **fig. 1B**. In this circuit, the inputs to the two audio channels are connected in parallel. One channel is used **only** to develop the control voltage; it regulates the gain of the other audio channel. This approach has

fig. 1. Audio compressor systems. The conventional compressor is shown in A; the dual audio amplifier system is illustrated in B.

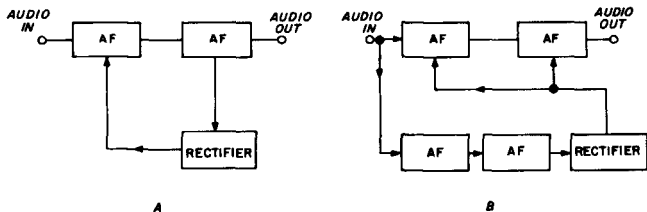

the advantage that a large amount of control voltage can be developed. In **fig. 1A**, part of the audio output must be rectified. Also, since the gain of both stages in the audio channel are controlled, you obtain more effective

with different characteristics couldn't be used to build a similar unit.

operation

The schematic of the dual-channel compressor is shown in **fig. 2**. If PC3 is forgotten for the moment, and the two leads between PC2 and PC3 are connected to ground, you can see that both PC1 and PC2 are conventional two-stage audio amplifiers. A feedback circuit from the collector of the second stage to the emitter of the first stage improves the frequency response and stability.

The only difference between amplifiers is the 300-ohm variable resistor in series with the 50- μ F emitter bypass capacitor of the first stage of one amplifier for gain adjustments. The function of this potentiometer is worth noting since the same action, automatically controlled, is used with PC3 to provide compression.

The output from one channel is connected to a 50k-ohm potentiometer on PC3 which

fig. 2. Schematic of the dual-channel compressor. The blocks show the three printed-circuit boards. The control amplifier board is on top, the controlled amplifier below.

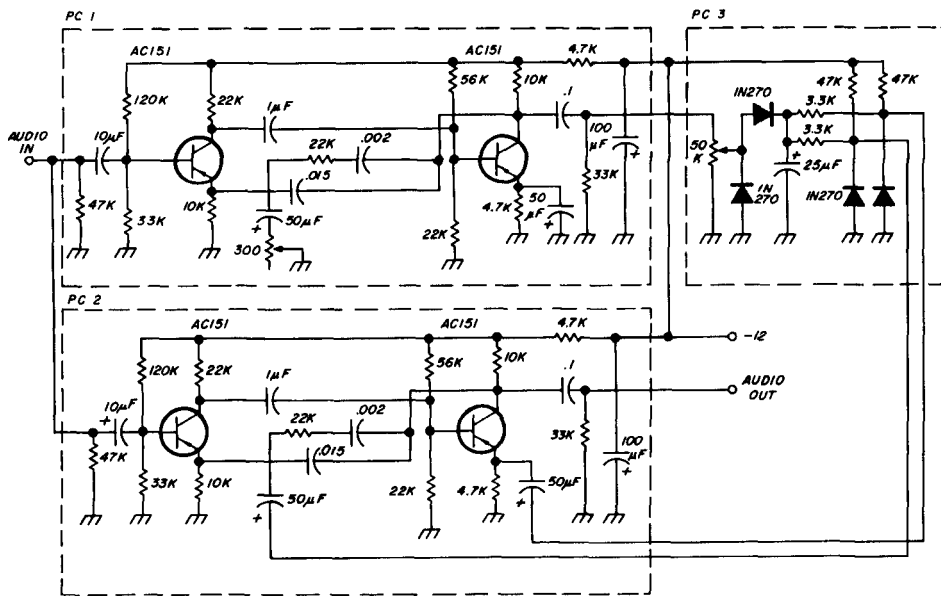

compression.

The audio channels I used were matched since they were part of a stereo preamplifier. However, there doesn't appear to be any reason why two separate monaural amplifiers

serves as a **compression level** control. The voltage from the potentiometer is rectified and coupled through 3.3k-ohm isolating resistors to 1N270 diodes in series with the emitter bypass capacitors of the other chan-

nel. The diodes are also connected to the 12-volt supply through 47k-ohm resistors.

When low-level audio signals pass through the amplifier channels, the negative voltage from the 12-volt source forward biases the diodes. The two 50- μ F emitter bypass capacitors are shorted to ground, and amplifier gain is maximum. As the signal level increases, an increasingly positive voltage is developed across the 25- μ F capacitor on PC3, and the diodes are reverse biased; the emitter bypass capacitors are no longer effective, the stages of the second amplifier become increasingly degenerative, and gain and output decrease.

adjustment

Adjustment of the compressor consists mainly of varying the 50k-ohm **compression level** control for the desired amount of compression. Although there is some noise build-up during speech pauses when using this compressor, it is less noticeable than with other circuits. This is probably because the

on PC3 should be reversed as well as the 25- μ F filter capacitors.

The components that are a part of PC3 can be mounted in any convenient location. In my compressor, they were mounted on a piece of Vectorboard and placed in one corner of the preamplifier. Connections from PC3 to the amplifiers should be as short as possible; hum may be a problem if the leads are too long.

If you have an amplifier where it's inconvenient to unground one end of the emitter bypass capacitors to obtain gain control, **fig. 3** shows two alternate methods for the same result. In the circuit shown in **fig. 3A**, a large bypass capacitor is connected between one or more stages in the controlled amplifier and the control diodes on PC3. When the diodes are forward biased by large audio signals, increasing amounts of the signal are bypassed to ground.

The one disadvantage here is that the frequency response of the amplifier will change

fig. 3. Alternate methods of putting a gain control between the stages of an audio amplifier.

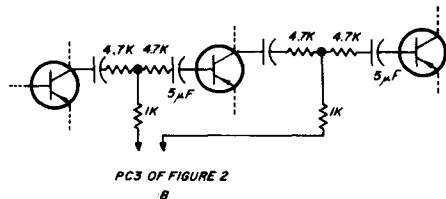
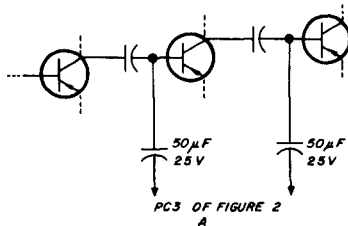

amplifiers were designed for low-noise, broad-frequency response and include generous amounts of feedback for stabilization.

construction

You can duplicate the circuit shown here, but more likely, you'll want to use existing amplifier circuits. In that case, you only have to worry about the components shown on PC3. Some variation in values may be necessary to suit individual applications. The 25- μ F filter capacitor and 3.3k-ohm isolating resistors may be varied to provide different time constants for compressor action. The 47k-ohm isolating resistors determine the point where compression becomes effective. If a positive supply voltage is used, all the diodes

with compression since a reactive element is used to bypass the signal to ground. This effect can be eliminated by placing a resistive T attenuator between the controlled stages as shown in **fig. 3B**. The control diodes on PC3 then act as a variable resistance leg in the T attenuator.

Since resistive elements are used, the frequency response of the controlled amplifier remains essentially unaffected. The shunt capacitor in **fig. 3A** and the resistors of **fig. 3B** will require some tailoring to your particular amplifier, but the values shown in the diagrams should work with most transistor audio amplifiers using conventional grounded-emitter circuitry.

ham radio

SPECIAL PACKAGE SALE!



SR-400 Cyclone Transceiver



HA-20 VFO



hallicrafters

SR 400 \$799.95

DS 500 AC \$119.95

\$919.90

OUR PRICE \$775.00

HA-20 VFO WITH ABOVE PACKAGE \$124

FRANCHISED DISTRIBUTOR AND SERVICE FOR



DISCOUNT PRICES. NO ONE ANYWHERE will beat our price! We will **TOP** any advertised or written price from any other dealer. We trade on both new and used equipment and we service what we sell. Instant credit on both new and used equipment. American Express and General Electric revolving charge.



International Electronic Systems, Inc.

280 ARAGON AVENUE, CORAL GABLES, FLORIDA 33134

305-444-6207

Cable: "INTEL"

Export orders our specialty



transistor rig for 40 meters

A crystal-controlled
five-watt
transmitter
for 7 MHz
using a 2N3553

Ed Marriner, W6BLZ and John Meredith, K5GXR, 528 Colima Street, La Jolla, California 92037 ■

If you want to go solid-state, here is a crystal-controlled 40-meter transmitter that has an output of two-and-one-half watts. It was built more or less as a curiosity, but it worked far better than expected. It's simple to build, uses one transistor, and is powered by a standard 12-volt lantern battery. The battery should last for several months of normal CW operation.

We often forget that in the early days of wireless, a five-watt transmitter was the average power most amateurs had on the air. Although there weren't as many layers of QRM then as there are now, an awful lot of QSO's were made. Even today, a low-power transmitter can give some surprises; one evening I worked a station near Sacramento, 500 miles away, with a 599X report. It was impressive. A whole new world opened up.

The similarity between the "old" days and the "new" becomes apparent when you start to buy parts for a transistor transmitter. The transistor costs about the same as a "bootleg" 210 did in the early thirties. Let's face it, transistors and associated tiny parts are expensive, and small switches and components are not available yet on the surplus market.

This transmitter costs about \$10.00 to build, but it depends somewhat on the parts you use. There are all grades, and prices vary considerably. Basically, the RCA 2N3553 power transistor costs \$4.75. You need that! A 50-

microamp meter can run anywhere from \$2.95 for an inexpensive imported tuning type without a scale up to \$15 or so. The inexpensive one does just as good a job here because it only functions as an rf output indicator.

You also need a power source. A lantern battery is the most convenient, and costs about \$3.00. An old 12-volt car battery and a trickle charger do a nice job; or you can build a power supply with a filament transformer—for more money.

circuit

This circuit is a Pierce-type crystal oscillator using a single 2N3553 transistor. The toroidal tank coil is used because the field is contained in a small space and miniature construction is possible. Capacitor C3 tunes the

used for rf output indication.

Keying is done in the emitter of the 2N3553. Capacitor C2 does a fine job as a key-click suppressor. The emitter current with a 12-volt collector supply is from 200 to 300 mA, depending on internal battery resistance as it increases with use. This represents 3 to 4 watts dc input. Collector-circuit efficiency runs about 70% at this level.

construction

The transmitter shown in the photographs is built in an LMB 138 chassis, 3 x 2-1/2 x 2 inches, although a larger chassis may be used for easy wiring. Placement of components and leads is not critical. The various holes in the chassis should be punched, drilled, and if possible, wired before starting assembly.

fig. 1. Schematic diagram of the one-transistor rig for 7 MHz. Power output of 2½ watts was measured with a Bird wattmeter. Construction of L1 and L2 is shown in fig. 2.

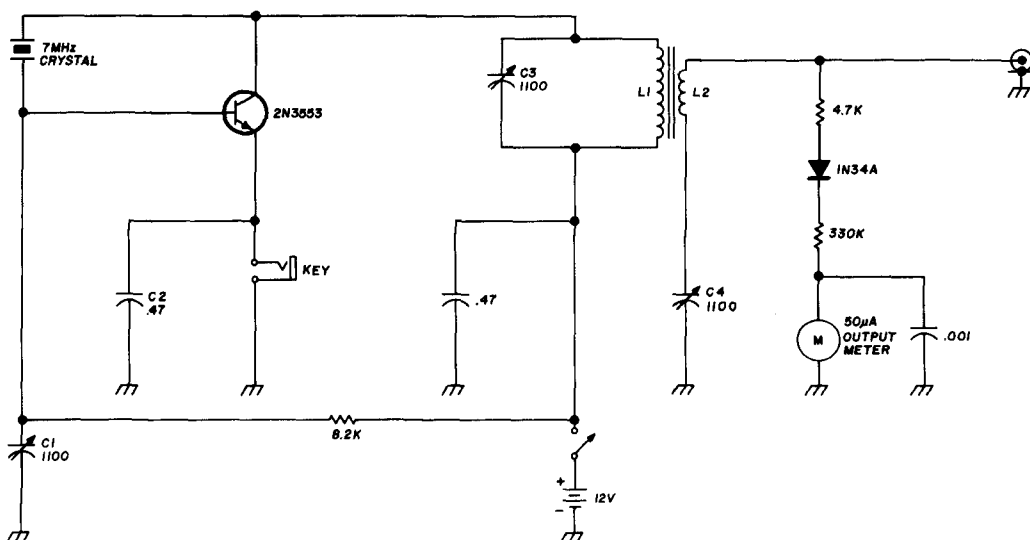

tank circuit to resonance on 40 meters, and C4 couples the load to the transmitter. Capacitor C1 is the feedback capacitor and is adjusted for proper keying and good circuit efficiency.

The antenna is inductively coupled to the collector of the 2N3553 through the final tank circuit and its link. Capacitor C4 controls antenna loading. The load impedance should be between 40 and 100 ohms resistive for proper operation. A relative power meter is

Construction of the toroidal tank coil, L1 and L2, is shown in fig. 2. L2 should be wound first using about ten inches of number-18 enamelled wire. Leave about one-and-one-half inches of lead, and count each turn as it goes through the center of the core. Space the turns so that the last turn is about one-eighth inch from the starting turn. Clip the excess wire so you have about one-and-a-half inches of lead left on L2. L1 is wound in a similar manner—starting 90 degrees clockwise

from the starting point of L2 and winding counter-clockwise from that point. Leave one-and-one-half inches of lead on each end.

The trimmer capacitors, tie lugs, crystal socket, key jack, antenna jack, power lead grommet, switch and meter are mounted in that order. The transistor should be provided with a heat sink and soldered in the circuit last. Be careful not to heat the transistor leads; use a heat sink such as long-nose pliers between the solder joint and transistor.

If you can't find all the parts at your local radio store, they can be purchased from any of the larger mail order distributors such as Allied Radio or Lafayette Radio. It's also a good idea to send postcards to surplus dealers and get on their mailing list; you'll find inexpensive meters and other parts necessary to build modern equipment.

tuning

After checking the circuit over carefully for wiring errors, connect the power supply. Take extra precaution, and check the polarity of the battery leads—this may save you a burned out 2N3553. Next, plug in a 40-meter crystal and connect the transmitter to a dummy load. You can make one from three parallel-con-

fig. 2. Construction of the final tank coil. Each winding consists of 11 turns number 18 enamelled on an Amidon Associates* T-94-2 ferrite core.

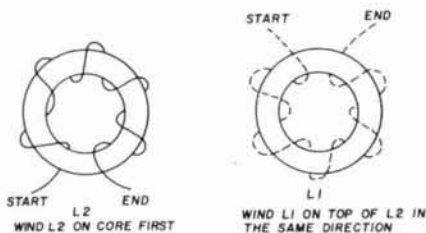

nected, 150-ohm, 1-watt resistors.

Tighten C1 to full compression, and then back it off two turns. Key the transmitter, and tune C3 until the output meter kicks. Tune C4 and C3 for maximum indication on the meter. If you don't get any output, try changing C1 while simultaneously tuning C3.

*Amidon Associates, 12033 Otsego Street, North Hollywood, California 91607.

Once you get output, tune C4 and C3 for maximum indication on the meter. Peak the output with C1 while listening to the keyed note on a receiver; set C1 for maximum power output consistent with good keying characteristics.

An antenna can now be substituted for the dummy load, and C3 and C4 tuned for

Internal parts layout of the 40-meter transistor transmitter.

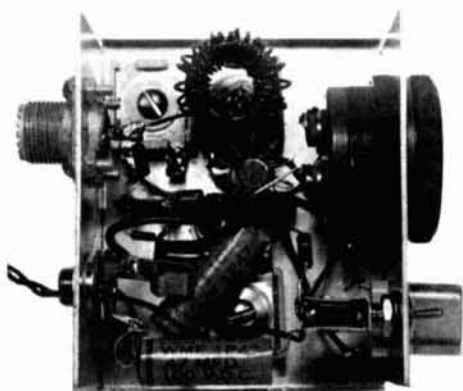

maximum output indication on the meter. If the antenna does not provide a resistive load between 40 and 100 ohms, use an antenna tuner.

To check power output, you can use an rf probe and a vtvm. You should measure 3 volts on the hot side of the 50-ohm dummy load.

results

This transmitter has been tested by several amateurs. WB60GA had excellent results throughout Southern California. K6WC made a critical check and found the keying clean with no trace of chirps or clicks at a distance of 13 miles. The ground signal was a constant S7 at this distance, indicating good possibilities of 40-meter skip for long-distance work. The overall dc to rf output conversion efficiency of 70% is ideal for portable battery operation or as a driver for a higher power amplifier; we'll build one as soon as we can save the money to buy a high power transistor!

ham radio

HEY! HOW ABOUT THAT

S.W.R. BRIDGE

- MODEL SWB-2
- READS FORWARD AND REFLECTED POWER SIMULTANEOUSLY
- "EASY READ" METERS
- USE FOR REFERENCE POWER METER
- DUAL 100-MICROAMP METER MOVEMENTS
- LOW INSERTION LOSS
- SIZE-5"X2"X2"

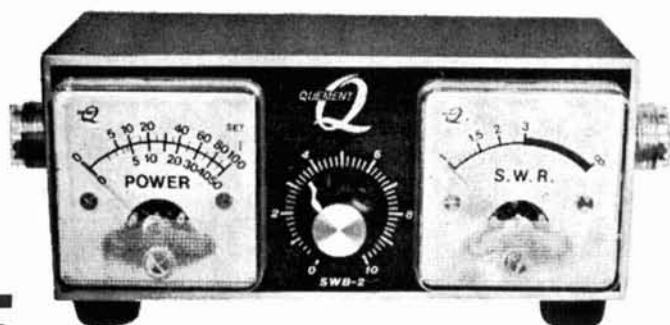

\$15.95

ALPHA 5100 FOR
PACKING & SHIPPING
CALIFORNIA RESIDENTS
INCLUDE SALES TAX

THE BEST
VALUE WE
HAVE
EVER
OFFERED!

MAY BE LEFT
IN LINE, UP
TO 2000 WATTS.

GOOD THROUGH
2 METERS

SINCE 1933

FAST SERVICE

Phone CY 4-0464

QUEMENT ELECTRONICS

1000 SOUTH BASCOM AVENUE

SAN JOSE, CALIFORNIA

"Northern California's Most Complete Ham Store"

95128

one year
FREE
three-year subscription to

ham radio

only \$10.00

regular one year rate \$5.00

ham radio magazine, greenville, new hampshire 03048

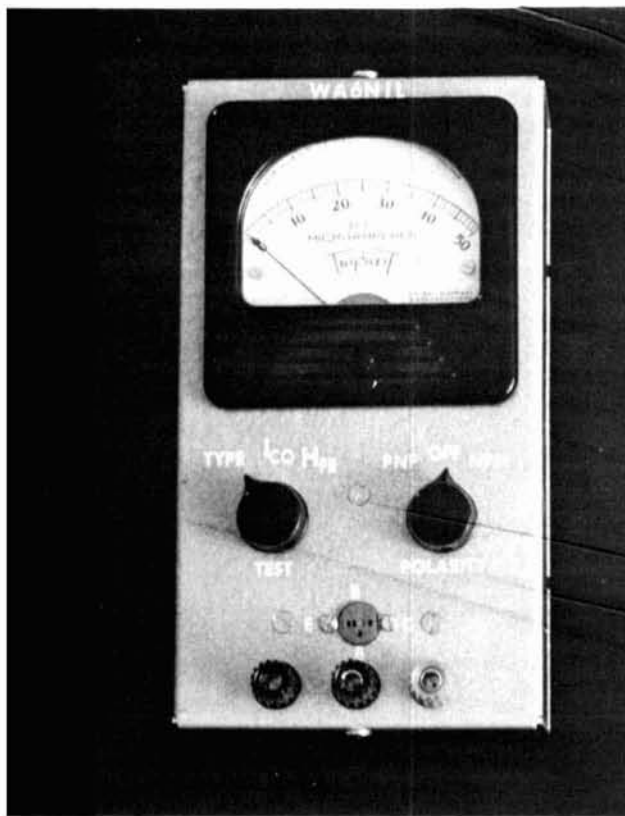

handy transistor tester

A transistor checker
for measuring type,
polarity,
leakage
and dc gain

James M. Lomasney, WA6NIL, 2501
Waverly Street, Palo Alto, California 94301

A **transistor tester** is almost a necessity for anyone who experiments with the little three-legged fuses. This one provides direct indication of transistor type (germanium or silicon), polarity (NPN or PNP), as well as I_{CEO} (collector leakage current) and h_{FE} (dc beta or common-emitter current gain). It is fast and easy to use; large batches of transistors can be sorted into types, the open and shorted ones picked out, and the rest graded for gain. Several of these testers have been built by members of local radio clubs and they have all worked very well.

The photograph of the instrument shows the two rotary switches, **test** and **polarity**, the universal socket which accepts the standard TO-5 or older three-in-line base and the three binding posts connected in parallel

with the socket. A worthwhile addition would be another socket to handle the small TO-18 transistors.

operation

Operation of the tester is straightforward. When starting with a transistor of unknown type, turn the **test** switch to **type** and the **polarity** switch **off**. Plug in the transistor and turn the **polarity** switch to **PNP**. A meter reading below 10 on the 0-50 scale indicates that you have a germanium PNP device, while a reading of 20 to 30 indicates a silicon PNP transistor.

A reading near full scale shows you have an NPN transistor; throw the **polarity** switch to **NPN**. Again, a reading below 10 shows a germanium NPN unit, and a reading of 20 to 30 shows a silicon NPN. If the reading is near full scale in NPN position too, the transistor is either open or not properly plugged in. If the test transistor is shorted, the meter will read near zero in both **NPN** and **PNP** positions.

Battery condition may be checked on the meter: with no transistor plugged in, and the **test** switch in the **type** position, turn the switch to either **NPN** or **PNP** polarity and read the meter. When it drops below 45 on the 0-50 scale, the batteries should be replaced.

With the **polarity** switch in the correct

position for the test transistor, turn the **test** switch to I_{CEO} . Read the leakage current in microamperes. A good germanium transistor should read less than ten, and a good silicon transistor less than one microampere. Now turn the **test** switch to h_{FE} and read beta on a 0-250 scale (multiply the 0-50 scale reading by five).

When sorting through a batch of the same type transistors to pick out high-gain devices, leave the **polarity** switch in the proper (**NPN** or **PNP**) position and the **test** switch at h_{FE} . Plug the transistors in, and note the beta reading of each.

Diodes may also be tested on this instrument. Connect them to the **C** and **B** pins on the socket or binding posts, cathode to **C**. Turn the **polarity** switch to **NPN** and the **test** switch to **type**. A germanium diode will read below 10, and silicon, 20 to 30 on the 0-50 scale. If the meter reads full scale, you have the diode in backwards or an open device; reverse the leads or throw the switch to **PNP**. If the meter still reads full scale, the diode is open. With the proper polarity, turn the **test** switch to I_{CEO} and read leakage current. If the meter needle goes full scale, the diode is shorted.

the circuit

The circuit, **fig. 1**, appears more complicated than it actually is. To understand the operation of the various test circuits, refer to the simplified diagrams in **fig. 2**. For the **type** test, **fig. 2A**, the meter is connected to the battery through a string of resistors just large enough to make the meter read full scale at full battery voltage. A tap is made on the resistor divider at the point where the voltage drop across that part of the string including the meter is one volt.

The transistor is connected across this one-volt drop so that its collector-base and emitter-base diodes are forward biased. With a germanium transistor with a forward drop of about 0.15 volt, the meter will read below 10 on its 0-50 scale; with a silicon transistor with about 0.5 volt drop, the meter will read between 20 and 30. An NPN transistor connected as shown will not conduct at all, and the meter will read full scale, indicating that the other position of the **polarity** switch

Layout of the handy transistor tester is not critical. A copy of the schematic is pasted on the back cover for ready reference.

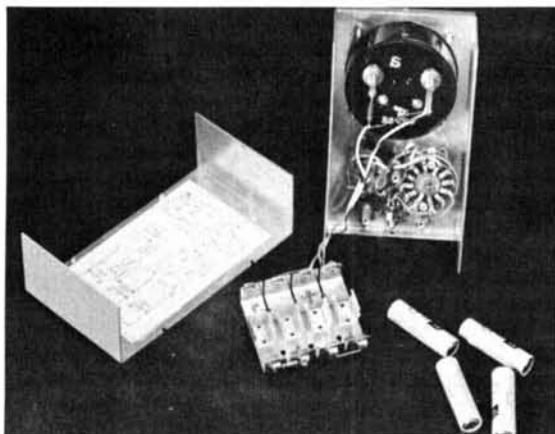

should be tried.

The collector-cutoff leakage current circuit is quite usual (fig. 2B). The battery is connected through the microammeter and a protective resistor to the collector-base diode of the transistor, reverse-biasing it. A good silicon transistor should show practically no leakage current, less than 1 microampere, and a small germanium type, less than 10 microamperes. Large germanium power types will generally show too much leakage for this tester.

The dc beta (h_{FE}) test circuit is shown in fig. 2C. The battery voltage is applied through R1 to the base-emitter junction of the transistor. The value of R1 is chosen so that the base current is approximately 20 microamperes. The battery voltage is also applied to the collector through the meter and R3. The meter circuit is shunted by R4 to read 5 milliamperes full scale.

The collector current is essentially the base current multiplied by dc beta. The meter may be calibrated directly in h_{FE} (dc beta) if you want, with a full-scale reading of 250 ($5 \text{ mA} \div 20 \mu\text{A} = 250$). I did not bother to do this because it's easy to mentally multiply the 0-50 scale reading by 5.

The value of R1 is a compromise. The voltage drop across it is the battery voltage minus the base-emitter diode drop, which is not the same for silicon and germanium transistors. Therefore, the battery voltage should be high in comparison to the change in diode drop, so that the current through R1 is nearly independent of the transistor type. On the other hand, the battery voltage should be low so that the collector-breakdown rating is not exceeded. A compromise must be made, and 6 volts is a reasonable value.

The circuits for testing an NPN transistor are exactly the same as shown in fig. 2, except that the polarity of both the battery and meter are reversed by the polarity switch.

The dc beta reading is only moderately accurate and is affected by battery loading and aging, differences in emitter-base voltage drops between silicon and germanium transistors, and resistor tolerances. In addition, the collector-leakage current adds to the 20 microampere base current through R1 to make the beta read high, especially with germanium transistors. The readings are suffi-

ciently accurate for most amateur purposes, however.

Returning to the overall circuit diagram of fig. 1, the test switch S1 selects any of the three circuits of fig. 2. The resistor R1 is put in series with the meter resistance (1100 ohms in my meter) to bring the total voltage drop

fig. 2. The three basic test circuits incorporated in the handy transistor tester. PNP transistors are shown here—for NPN devices, reverse battery and meter polarities.

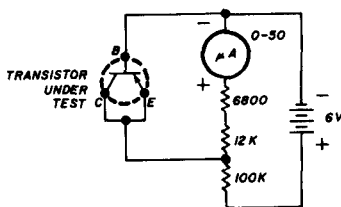

A. Type test

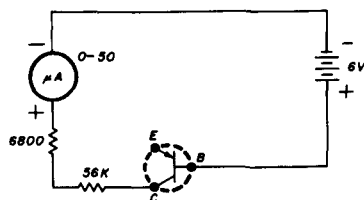

B. Collector-cutoff leakage test (I_{CEO})

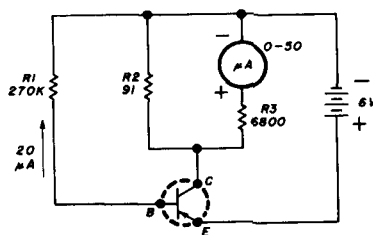

C. DC current gain test (h_{FE} or beta)

at full-scale meter current to about 0.4 volt. A protective diode D1 is connected across this part of the circuit; it draws practically no current when the meter is on scale, but will not allow more than about 50% overload current to flow. D1 may be almost any silicon diode (not germanium). It must be connected as shown—it will not protect the meter if it's put in backwards.

The three bypass capacitors at the socket are small ceramic discs with very short leads. These help to keep the very hot vhf transistors from self-oscillating under test.

construction

Layout and construction are not critical, but when you're wiring a circuit with a sensitive meter and a battery, mistakes can be expen-

only unusual part is the **test switch S1**, a non-shorting, four-pole, three-position rotary switch. I used a Centralab type PA-2011, modified by using shorter spacers and sawing off the rear of the shaft to make room to mount the battery holder behind it. The **polarity switch**, also a four-pole, three-position unit, may be either shorting or non-shorting since the center position is **off**. I used an

fig. 1. Schematic diagram of the handy transistor tester. Rotary switch S1 should be a non-shorting type.

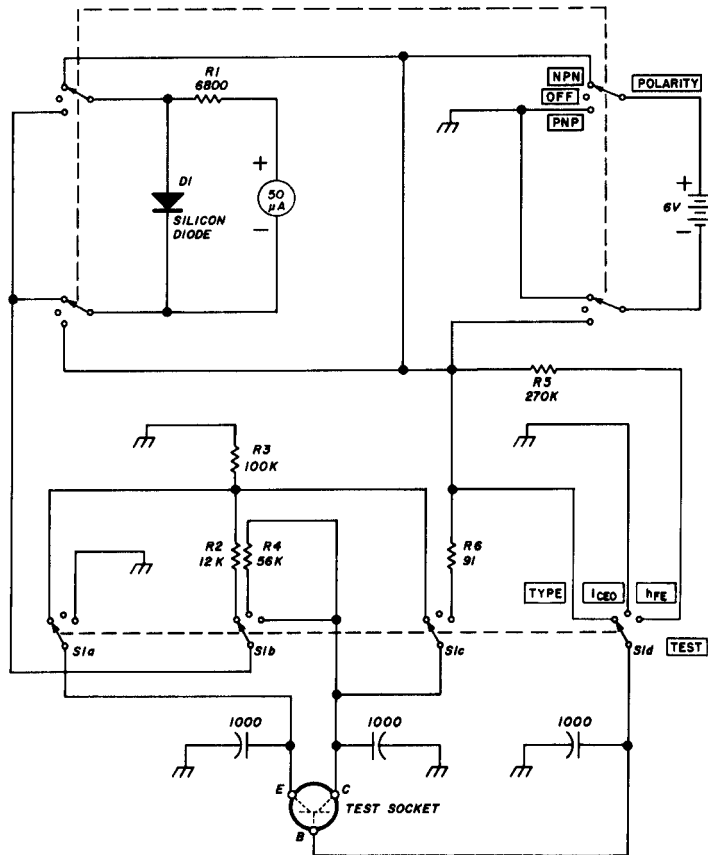

sive. For one thing, don't try to measure meter resistance with an ohmmeter! The unit shown in the pictures is built in an LMB 138 chassis-box, but anything big enough to hold the meter and other parts will do. The battery holder is mounted on spacers behind the rotary switches.

The most expensive part is the meter. A 50-microampere movement is desirable to measure the leakage current of silicon transistors, but less sensitive meters can be substituted as described later. Aside from this, the

inexpensive imported switch (Lafayette #99-6156).

Four 1.5-volt penlite cells are used for the power supply. Alkaline batteries are excellent, since their voltage holds up over long periods of time; mine are over a year old and still going strong. Even more constant voltage and longer life may be obtained with mercury or rechargeable nickle-cadmium cells, but their slightly different voltage (5.36 volts for 4 cells or 6.7 volts for 5 cells respectively) would require adjustment of resistor

values.

Changing the circuit to accommodate a different meter, a different battery voltage, or a different dc beta range only requires a bit of Ohm's law. R1 should be chosen so that the total voltage drop across it and the meter is 0.4 volt at full-scale meter current. R2 is then picked so that the voltage drop across the meter, R1, and R2 is one volt at full-scale current. R3 is now calculated so that the total voltage drop across the meter, R1, R2 and R3 is equal to the voltage of new batteries at the same current. R4 is not critical—large enough to limit the meter current to about two or three times full scale if a shorted transistor is plugged in during the I_{CEO} test.

R5 is picked for an average 20 microamperes base current (slightly under 20 with a silicon transistor, slightly over with germanium). To compute R5, the voltage drop across it may be taken as the voltage of new batteries minus 0.35 volt.

R6 is selected to shunt the series combination of the meter plus R1 to read the desired full-scale current for the beta scale; that is, 20 microamperes times the full-scale beta reading. As an example, suppose you have a 0-150 microampere meter with 500-ohms resistance. The total resistance of the meter plus R1 is $0.4V \div 150 \mu A$ or 2667 ohms. R1 is 2667 ohms minus 500 ohms, or 2167 ohms; 2200 ohms is close enough.

Now, suppose you want a full-scale beta reading of 300; this will go nicely with a 0-150 meter scale. The total collector current will be 20 μA times 300, or 6 mA. Of this, 150 microamperes will flow through the meter, leaving 5.85 mA for the shunt, R6. The value of R6 is $0.4V \div 5.85 \text{ mA}$, or 68.4 ohms, and a 68-ohm resistor can be used. Judicious selection of resistors and checking them against an external meter will give better accuracy than just picking the resistors out of the junk box.

I assume that you know which leads are which on the transistor being tested. If you should run into an unknown oddball, a method of identifying the connections was described by W9QKC¹. This is an excellent article and well worth rereading. Transistor base diagrams have also been published in various books^{2,3}.

I finished up my tester by gluing a copy of the circuit diagram inside the back cover, and short operating instructions on the outside. It's a great comfort to have this information available right on the instrument after a couple of years when you've forgotten what you put in it. For a really deluxe job, you could make up a special meter scale with "Germanium - Silicon - Reverse" sectors and a direct-reading dc beta scale.

The completed tester is fast and convenient enough to be kept right on the bench while you're building up experimental circuits. Whenever you suspect that the transistors you are using have been damaged, this checker saves a lot of time and exasperation. You'll soon wonder how you ever got along without it. Many thanks are due to Dave Annett, WB6DBE, for taking the photographs, and to Lloyd Provan for enlarging them.

references

1. Donald Grayson, W9QKC, "How to Check Transistors with an Ohmmeter," 73, March 1962, p. 14.
2. "General Electric Transistor Manual," Seventh Edition, 1964, pp. 575-589.
3. "RCA Transistor Manual," SC-13, 1967, pp. 449-456.

ham radio



NEW!



TYPE PERFECT CODE

will complete it and, indeed, let you depress the next key without disturbing it. The AC-1 has provision to make AR, SK etc. without gaps.

The Autovolt Alphacoder Model AC-1

The new Autovolt Alphacoder, AC-1, makes any letter or digit with one stroke of your finger. You can produce perfectly uniform code, including preset letter-to-letter spacing using the standard electric typewriter keyboard of the AC-1.

It is only necessary to start a letter, an automatic electronic latch

\$395.00

also

The Autovolt Memokey, Mk-2

A self-completing
automatic keyer featuring

- Instant letter start
- Both dot and dash memories
- Iambic output



The instant letter start frees you from the frustration of synchronizing yourself with a pulse stream when starting a new letter. The AC-2 starts immediately when you hit the first contact.

The memories allow you to "read in" one dot or dash ahead and still produce perfect code. In practice, it's best to aim a little ahead, but less than the full amount possible. Then the memories will absorb timing errors in either direction.

The iambic output (.-.-.- etc.) is generated when you close both contacts of a dual paddle key. This enables you to make many letters by a single educated squeeze of the paddles.

If you use a single lever key the Memokey will function perfectly in that mode. The motions that operate a non-memory keyer will also operate a Memokey. Similarly with the instant start. Later on, you may want to get a dual paddle key and try squeeze keying. The price of the Memokey has been made competitive by using the more efficient circuitry that made the Alphacoder, AC-1, practical. The ability of the Memokey to cover all bases makes it a best buy.

The MK-2 has a built in sidetone with loudspeaker output and a built in power supply to operate it from the 117 V, 60 Hz. line.

If you already have a sidetone system, you can obtain identical results from the MK-1, which omits the sidetone and runs from 8 penlite cells. This is practical because the novel circuitry of the MK-1 uses only 7 ma. key "up" and 40 ma. keyed. It's in the same attractive enclosure as the MK-2.

Memokey, Mk-1 \$65.00

Mk-2 \$85.00

All of the units described are of solid state design. They include a 100 VA reed-type relay with "floating contacts" for greatest flexibility in transmitter control.

All prices FOB Boston, Mass. 25% with COD orders, please
To order or for further amplification of details write



AUTOVOLT, INC.

68 RICHMOND RD., BELMONT, MASS. 02178 • 484-4954

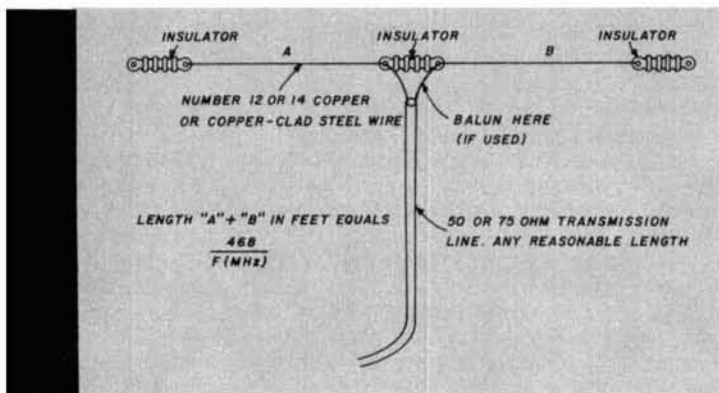

fig. 1. Basic half-wave dipole antenna.

simple 1-, 2- and 3- band antennas

A discussion
of the merits
and design
of various
multiband dipoles

Herbert S. Brier, W9EGQ, 385 Johnson Street, Gary, Indiana 46402

The most popular single-band amateur antenna for the lower-frequency bands is the half-wave dipole fed in the center with flexible, low-impedance coaxial line. The dipole length is calculated from a formula that is found in most of the handbooks: length (feet) = 468/frequency (MHz). Calculated half-wavelengths for representative frequencies in the 3.5-, 7-, and 14-MHz amateur bands are shown in table 1.

Although the size of the wire, the method of fastening insulators, and proximity to other objects will have some effect on the antenna's resonant frequency, it's surprising how close a carefully measured and constructed antenna will resonate to the design frequency.

horizontal vs. inverted-v antennas

Many 3.5- and 7-MHz dipoles are installed as "inverted V's" (center high, ends low), because it is easier to put one short stick on the house to support the center of an inverted V than to install two high poles to support a horizontal antenna. However, for the same (center) height, the horizontal antenna usually gets out a little better because of its greater separation from power-absorbing objects.

antenna height

For daytime work on 80 and 40 meters, and for close-in work on the other bands, antennas 20- to 25-feet high perform about as well as higher antennas. But over longer distances, average results improve almost linearly with heights up to 50 feet, and more slowly for greater heights. Nevertheless, a low antenna outperforms a high one often enough to make it interesting—especially over medium distances.

length vs. frequency

When you want to resonate an antenna on a precise frequency, cut it slightly longer than the calculated length and put it up. Then insert an **accurate** SWR bridge in the transmission line and measure the SWR at different frequencies near the design frequency. When the frequency of minimum SWR is found, shorten the antenna to obtain minimum SWR at the *desired frequency*.

On the 3.5-MHz band, the resonant frequency of a half-wave horizontal dipole changes approximately 2.5 kHz per inch—slightly less near 3.5 MHz and slightly more near 4.0 MHz. On 40 meters, the change is about 9 kHz per inch, and on 14 MHz, about 36 kHz per inch.

antenna impedance

In free space, the theoretical impedance of the center of a lossless half-wave antenna of zero diameter is close to 73 ohms. Practical antennas installed at heights that are integral multiples of one-quarter wavelength (70 feet at 3.5 MHz, 35 feet at 7 MHz and 17.5 feet at 14 MHz) have center impedances which are quite close to the theoretical value. The impedance fluctuates above and below this nominal value at heights that are *odd* integrals of 1/8-wavelength. For example, at heights of 3/8 wavelength (105 feet at 3.5 MHz, 52 feet at 7 MHz, and 26 feet at 14 MHz), the impedance goes up to 95 ohms. And at a height of 3/8 wave (170 feet at 3.5 MHz, 85 feet at 7 MHz, and 42 feet at 14 MHz), the center impedance drops to about 58 ohms. Similar, but gradually lessening, fluctuations occur at higher odd multiples of 1/8 wavelength.

Below 1/4 wave, the center impedance of a half-wave antenna goes down with decreasing heights, and over a perfect ground, the impedance will reach a very low value at heights of less than 3/16 wave. Over actual ground, losses increase rapidly as antenna height decreases, and the effective center impedance of a horizontal half-wave antenna stabilizes between 40 and 50 ohms for heights under 1/8 wave or so.

Translated into practical terms, 52-ohm coaxial cable matches the center impedance of horizontal 3.5-MHz dipoles at heights of up to 50 feet quite well. For greater heights, 75-ohm coax is a better choice. It is also recommended for dipoles on 7 MHz and higher for heights above 30 feet or so.

antenna baluns

Simple, center-fed dipoles first achieved popularity with the development of efficient, flexible, low-impedance, twin-lead transmission lines which matched their nominal 73-ohm center impedance. Even after transmitters with unbalanced pi-network output circuits became standard, many amateurs continued to use twin lead to feed their dipoles by grounding one conductor and connecting the other one to the hot output terminal of the transmitter.

Although this arrangement worked fine, the word gradually got around that you couldn't feed a balanced transmission line from an unbalanced pi-network. As a result, most amateurs dutifully switched from twin lead to coaxial cable. And our antennas worked fine—just as well as when fed with twin lead. Next, the theoreticians came up with the edict that you couldn't feed a balanced antenna with unbalanced coaxial cable unless you put a balancing device such as a balun between the line and the antenna.

This means that all the dipoles, Gamma-matched beams, split-dipole beams, etc., fed directly with coaxial cable really did not work; we just thought they did. Being great believers of theory, we quickly installed baluns between our coaxial transmission lines and balanced antennas—with just about the same results as before.

However, I do have to give the antenna

balun its due. When a balanced horizontal antenna is installed on a site free of trees, tall buildings, and utility wires that might distort its radiation pattern, and fed with coaxial cable and a balun, the local radiation pattern is symmetrical. When the balun is removed from the circuit, the radiation pattern skews slightly towards the side of the antenna connected to the center conductor of the coaxial transmission line.

Furthermore, with the balun installed, reception of local vertically-polarized signals is usually somewhat poorer than with the balun removed. This indicates that the balun prevents vertically-polarized signals and noise picked up on the outer conductor of the coaxial transmission line from getting into the receiver.

simple multi-band antennas

Undoubtedly, the most-efficient simple multi-band antenna is a half-wave dipole at the lowest operating frequency, center fed with open-wire transmission line coupled to the transmitter through an antenna coupler. The transmission line may consist of open-wire TV ladder line or a pair of number 14 or 12 conductors spaced two to four inches apart.

Although the SWR may be quite high with this arrangement, line losses are still lower than with a perfectly matched coaxial line of the same length on the same frequency.

table 1. Lengths of half-wave dipoles for 3.5, 7 and 14 MHz.

frequency (MHz)	length
3.5	133' 8"
3.7	126' 6"
3.8	123' 2"
3.9	120' 0"
4.0	117' 0"
7.0	66' 10"
7.1	65' 11"
7.2	65' 0"
7.3	64' 1"
14.0	33' 5"
14.1	33' 1"
14.2	32' 11"
14.3	32' 9"
14.35	32' 7"

Nevertheless, many amateurs shy away from open-wire feeders because they don't like antenna couplers. Also, open-wire line is somewhat more trouble to install than coaxial cable.

trap antennas

One popular multi-band antenna is the "trap" dipole. In a 3.5- and 7-MHz antenna for example, a pair of 7-MHz parallel-resonant "traps" are inserted in a 3.5-MHz dipole 1/4-wavelength (at 7 MHz) on each side of the center insulator as shown in fig. 2. At

fig. 2. An 80- and 40-meter trap dipole with typical values for operation on 7.2 and 3.9 MHz.

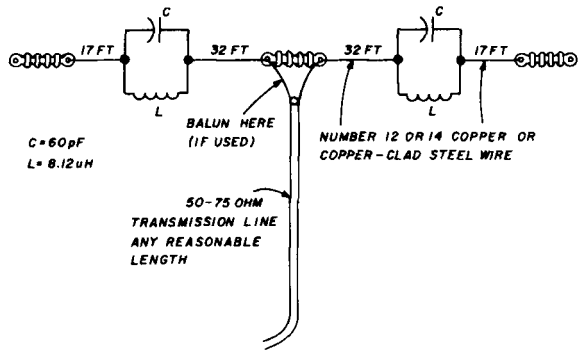

their resonant frequency the traps look like very high-resistances—like insulators, in fact—inserted in the antenna. On 7 MHz, therefore, the section of the antenna between the two traps acts like a conventional half-wave dipole.

At 3.5 MHz, the traps exhibit inductive reactance and act as loading coils to decrease the resonant frequency of the antenna. Resonance is restored by cutting off the end sections of the antenna. The overall length is usually reduced about 10 per cent.

Adjustment of the antenna consists of inserting an SWR meter in the transmission line and adjusting the lengths of the inner sections of the antenna for minimum SWR at the desired frequency in the 7-MHz band. Then, operations are transferred to 80 meters; the lengths of the end sections of the antenna are adjusted for minimum SWR at the desired frequency. If the lengths of the outer

sections are changed only a reasonable amount, it will have very little effect on 7-MHz resonance.

Incidentally, an almost endless combination of tuned-circuit values and conductor lengths may be used to obtain operation on two or more discrete frequencies, but adjustments can become quite tedious.

The efficiency of two-band trap antennas is almost the same as the efficiency of conventional dipoles on the lower frequency of operation. At the higher frequency, however, trap losses do reduce antenna efficiency. In one such 40- and 80-meter antenna using traps with a Q of 180, losses were just under 1 dB on 40 meters.

but at 7250 kHz, the SWR will be exceedingly high.

If the frequency is increased above 7250 kHz, the SWR will decrease to a minimum near 7800 kHz (the second harmonic of 3900 kHz). The explanation is this: at 7800 kHz, the 3900-kHz dipole appears as a simple high resistance across the transmission line. Below 7800 kHz, however, it looks like a capacitor in parallel with the resistance across the transmission line. The resulting capacitive reactance pushes the SWR up.

The solution to the problem is both simple and effective: increase the length of the higher-frequency dipole so it will present inductive reactance to the transmission

fig. 3. Two-band multi-dipole antenna.

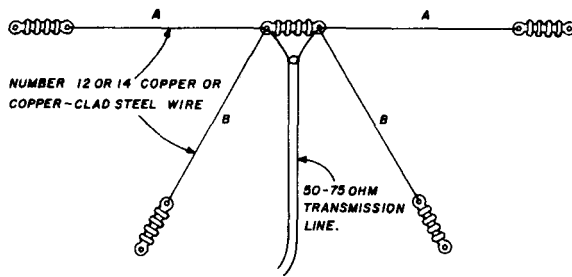

$$\text{LENGTH "A" + "A" (LOWER FREQUENCY)} = \frac{468}{\text{FREQUENCY (MHz)}}$$

$$\text{LENGTH "B" + "B" (HIGHER FREQUENCY)} = \left(\frac{468}{\text{FREQUENCY (MHz)}} \right) + "X"$$

"X" = FREQUENCY CORRECTION FACTOR (SEE TEXT)

multiple-dipole antennas

Another simple multi-band antenna is the multiple-dipole shown in fig. 3. Referring to the figure, on the lower frequency band the longer pair of wires act as a conventional half-wave dipole, with the shorter wires having negligible effect on the operation. On the higher band, the short dipole radiates, and the long one goes for the ride.

As long as the two dipoles are resonant on harmonically related frequencies—say 3525 and 7050 kHz—operation is as described; otherwise, strange things occur. As an example, assume that the low-frequency dipole is resonant on 3900 kHz and the high-frequency one is tuned to 7250 kHz. At 3900 kHz, the antenna will perform as predicted;

line. This will cancel out the capacitive reactance presented to the transmission line by the lower-frequency antenna.

Assuming that the minimum SWR occurs at 7800 kHz and you want minimum SWR at 7250 kHz—a difference of 550 kHz—then the dipole should be lengthened approximately five feet for minimum SWR at 7250 kHz. This is based on the fact that the resonant frequency of a 40-meter dipole changes approximately 9 kHz per inch.

An important precaution in installing multiple-dipole antennas is to space the ends of the shorter dipole at least a foot (preferably more) from the longer one. Otherwise, slight variations in the spacing between the two antennas as the wind blows will cause a

LOW PRICE, QUALITY, COAXIAL SWITCHES...



Don't pay for the 5th and 6th position. The average HAM rarely uses more than 4!

SPECIFICATIONS: Silvered Contacts. Write-on ERASABLE escutcheon plate. AVAILABLE EITHER 4 PST (COAX-4) OR LINEAR (COAX-LINEAR) IN-OUT VERSION. Handles 1000 W AM or 2000 W SSB. Insertion loss negligible to 160 Mc. VSWR: Less than 1.2 at 160 Mc. Size: $3\frac{1}{4}$ " dia. x $1\frac{1}{4}$ " overall. Single hole mount. SPECIFY MODEL. \$7.65 ea.

COAXIAL LIGHTNING ARRESTORS

Zero power loss. No increase in SWR at 150 Mc. Does not attenuate signals. Model 210 for 1000 W (AM) or 2000 W (SSB). Model 211 Electronic static arrester for 50 W (AM) or 100 W (SSB). SO-239 UHF type fittings. Other fittings available. Size approx. $3\frac{1}{2}$ " x $3\frac{1}{4}$ " dia. #210 \$3.15 ea. #211 \$4.65 ea. SPECIFY model #.



PRICES above are amateur net. Shipped ppd. in U.S.A. Send Check or M.O. (N.J. ADD 3% Sales Tax)

OTHER PRODUCTS: Feed thru capacitors. Tuned noise filters. Alternator, generator, low-pass and field filters. SEND FOR CATALOG.

"COMMUNICATION ENGINEERED"
By "HAMMIE" RICHARDT—W2WIY

ELECTRONIC APPLICATIONS CO.
ROUTE 46, Pine Brook, N. J. 07058

NOISE BLANKER

Removes interference generated by auto ignitions, appliances, radars, and other sources of high energy pulse noise.



Provides the noise suppression required for reception of weak VHF DX and scatter signals. Connects between converter and receiver; for 50-93 ohm coax. Solid-state design features silicon Field Effect Transistors for reliability and minimum cross-modulation. Adjustable output coupling for optimizing system gain.

Send for technical brochure TNB

WESTCOM ENGINEERING COMPANY
P.O. Box 1504 San Diego, Cal 92112

large variation in feedline SWR. One way to assure adequate spacing between the two dipoles is to install one of them horizontally and the other one as an inverted V.

More than two dipoles can be fed from the same transmission line, but the secret to success is to cut each one somewhat longer than the calculated length. Then, starting at the lowest frequency, trim each one for minimum transmission-line SWR at the desired frequency.

three-band antennas

A rather neat three-band antenna can be made by combining a 3.5- and 7-MHz trap

fig. 4. A three-band antenna combining the features of the trap and multi-dipole antenna.

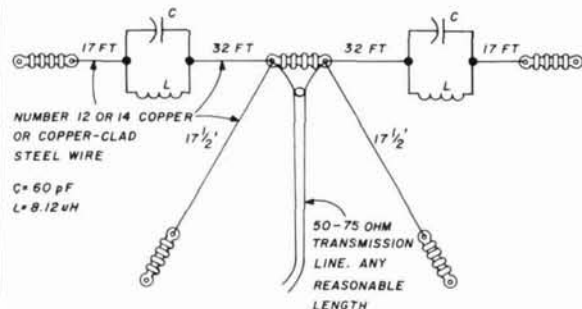

dipole with an extra dipole for a third band, as shown in fig. 4. With the lengths shown in the drawing, the antenna is resonant on 3900, 7250, and 14200 kHz. While this antenna is no world-beater on 20 meters, it does all that can be expected of it on the three bands.

harmonic radiation

Some amateurs avoid multi-band antennas from fear of excessive harmonic radiation. Fortunately, if the transmitters or transceivers they are used with have adequate harmonic suppression built in and are properly adjusted, harmonic radiation should be no problem. Of course, it is always wise to check harmonic radiation with any new antenna, and if necessary, use an antenna coupler to prevent excessive harmonics from reaching the antenna.

ham radio

Why don't they . . .

1. make 10- and 15-meter transverters for the popular triband, single-band, and other transceivers?

Since there are thousands of limited-frequency range transceivers in use, why not? Could be of interest to a manufacturer or for home-brew articles.

2. make 432-, 1296-MHz and higher frequency elements for replacement of TV elements in uhf TV parabolic reflectors?

Sounds like a good idea. Perhaps some enterprising manufacturer who wants to sell more antennas will come up with it after reading this!

3. do away with credit slip refunds for small amounts by dealers?

Agreed! I have them in all different shapes, forms and amounts. It is annoying. I can see no reason why postage stamp refunds cannot be made. Hams can always use them.

4. make brass chassis for vhfers, or at least plates to fit standard chassis for home-brew converters, etc?

Here's an opportunity for someone in the business, or someone who wants to get into the business, to do so. Might as well make cavities, or boxes to use as cavities, for uhf, etc. Also brass tubing for baluns.

5. allow credit for commercial radiotelegraph license code tests for the Amateur Extra Class? *I don't know. Seems like it would accomplish the same purpose and save Uncle and the taxpayer money. Why not ask your ARRL Director?*

6. include low-level output jacks on transceivers for low power so that the final can be turned off for local contacts, to drive transverters, etc?

Right. It shouldn't be necessary to "swamp" a 150 or 500 watt transvert. I did this with a KWS-1 for 28 MHz without drilling or using a soldering iron. Will be glad to tell anyone how, if you send me a stamped, self-addressed envelope.

Chas. Spitz, W4API



RECONDITIONED HAM GEAR JULY SPECIALS

RECEIVERS

BTI		
LK2000 Demo		\$695.00
COLLINS		
75A3 3.1 KC Filter		\$219.00
75A4 (early model)		349.00
75A4 (late Ser. #4500) w/spkr		459.00
75S-1		349.00
516F2 AC Power supply		110.00
DRAKE		
2-B Receiver		\$189.00
2CQ Q Multiplier		29.00
L4 (Brand New) Linear (sealed cartons)		595.00
HALLICRAFTERS		
SX99		\$ 79.00
SX100		130.00
SX101-Mk-III		169.00
HAMMARLUND		
HQ140X		\$119.00
HQ160		159.00
HQ170		179.00
HQ170A		219.00
HQ170C		189.00
HQ180		279.00
SP600-JX17		249.00
HEATH		
HR-20		\$ 89.00
GR-64		49.00
NATIONAL		
NC173		\$ 79.00
HRO 50 R w/Prod Det (4 Coils)		109.00
NC270		190.00
HRO-500 Demo		1495.00

TRANSMITTERS

CLEGG		
Venus Xceiver-6M SSB (Like New)		\$319.00
DRAKE		
TR-3 Xceiver		\$395.00
TR-4 Xceiver (demo)		559.00
T-4 Rectifier to transceiver w/R4A		239.00
GONSET		
G-50 6M Xceiver		\$179.00
HALLICRAFTERS		
HT 32		\$219.00
HT 37		229.00
HT 41 LINEAR		159.00
SR 42 A 2 meter xceiver		149.00
HEATH		
HW12 80 Meter XCVR		\$ 89.00
HW32 40 Meter XCVR		99.00
NATIONAL		
NCL-2000 Linear		\$359.00
P & H		
6-150-6M converter-mixer SSB		\$189.00
SWAN		
SW175 xcvr 75 meters		\$129.00
SW120 xcvr 70 meters		119.00
Mark 6 Linear		449.00
400 XCVR		339.00
250 6M SSB		229.00
RTTY		
Mod. 15 teletype machine		\$ 89.00
Mod. 14TD-units		45.00
Mod. 14 Reperfs w/keyboard		49.00

ALL CASH ORDERS SHIPPED FREE
IN THE 48 STATES

MISSION HAM ELECTRONICS

3316 Main Street, Riverside 3, California 92501
Phone 682-0523 (area code 714)

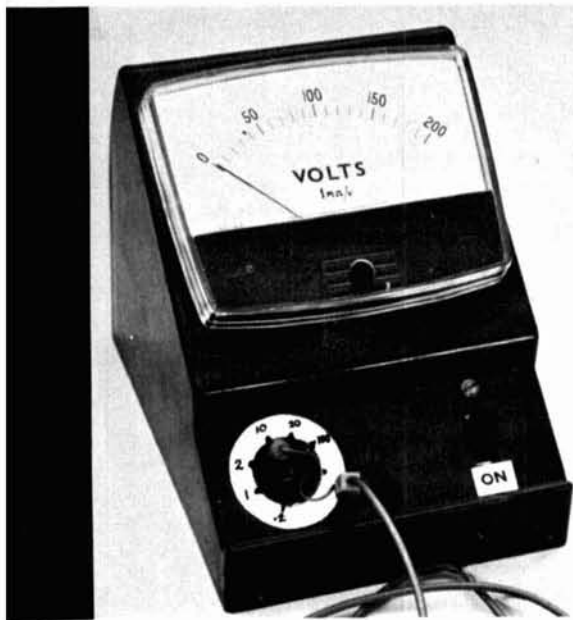

transistor voltmeter

A transistor voltmeter built around the design featured in the April issue of **ham radio** is shown in the accompanying photographs. The amplifier components are mounted on a small painted-circuit board which is attached directly to the meter terminals. The multiplying resistors are grouped around a miniature 7-pin tube socket which is used with pin plugs instead of a multi-position switch. This conserves space in the meter box.

capacitance measurement

An interesting feature of the scale is the diamond-shaped mark at 37 divisions. This is $100/e$, where e is 2.7, the base of natural logarithms. With this mark, you can approximate the value of larger capacitors very simply with the aid of a battery. Its use is based on time constant; if a capacitor (C) in parallel with a resistor (R) is charged to a voltage (V) as shown in **fig. 1**, when the voltage

R. S. Maddever, Geelong Grammar School, Corio, Victoria

source is removed, the voltage across the capacitor will decay to a value of V/e in RC seconds, where R is measured in ohms and C in farads.

In practice, R can be the input resistance of the transistor voltmeter, and the voltage source any suitable battery to provide meter deflection greater than 100. The transistor voltmeter is connected across the capacitor as

fig. 1.

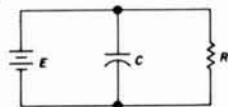
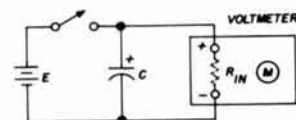
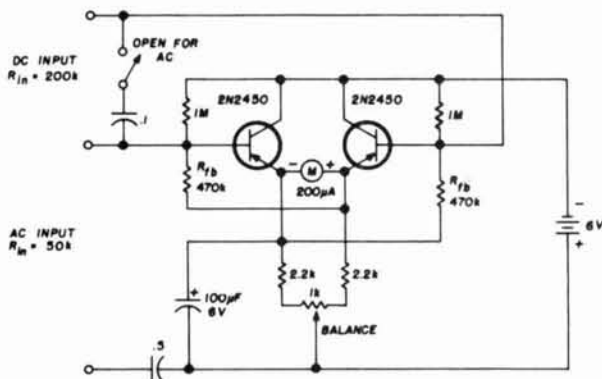

fig. 2.



shown in **fig. 2**, observing polarity if necessary. The battery is then connected to the circuit momentarily to charge C to anywhere above the 100-division mark. Then the length of time it takes the needle to fall from the 100

fig. 3. The transistor voltmeter. The $0.5 \mu\text{F}$ capacitor on the ac input should be a low-leakage, non-electrolytic type. The input terminal between the dc and ac inputs is common to both.



mark to the 37 mark is timed in seconds.

From the time-constant formula, the value of the capacitor can be calculated from $C = t/R$; where C is in μF , t in seconds and R in megohms. With the instrument pictured, the input resistance is 10 megohms on the 10-volt range. Therefore, a voltage decay timed at 25 seconds indicates capacitance of 25/10 or 2.5 μF .

This value is only approximate because we haven't considered leakage resistance in the capacitor itself. Strictly speaking, the value of R you use in the calculation should be the parallel resistance of meter input resistance and capacitor leakage resistance. If you want to see if the leakage resistance is appreciable, you can repeat the measurement on a different voltage range, and compare the two calculated values.

Alternatively, you can charge the capacitor up and measure the voltage across it on a range which does not discharge it very quickly; then disconnect it for a time and remeasure it. If the voltage has decreased appreciably, you can make an estimate of the internal leakage resistance.

Don't use a battery voltage higher than the

rating of the capacitor. For small capacitors, it is best to use the highest voltage range possible so the decay times are long and easily measured. The shortest useable times will vary with the inertia of the meter needle, but usually should be more than a second or two. On the 100-volt range (100 Megohm R_{in}) of my meter, the smallest capacitor that can be measured conveniently is about $.01 \mu\text{F}$. There is no upper limit capacitor size—if the decay time is too long you can always reduce the effective resistance with a parallel resistor.

ac measurements

I have found that by adding two capacitors to the meter circuit, it may also be used as an ac voltmeter of moderate linearity from at least 20 Hz to 200 kHz. The input impedance depends on the meter movement you use, but with a 200- μA meter, it will be on the order of 50k ohms per volt. The basic circuit is shown in **fig. 3**. The meter readings obtained with this circuit are listed in **table 1**.

The capacitor used to reduce hum and transient noise on dc settings must be switched out of the circuit for ac readings. If this isn't done, the same ac voltages are applied to both sides of the differential amplifier and there is no output. The large capacitor between the emitter and ground determines the low-frequency response of the instrument. With the value shown, the readings are within a few percent of the values shown in **table 1** from below 20 Hz to well above 200 kHz. To obtain

Parts layout in the transistorized voltmeter is not critical.

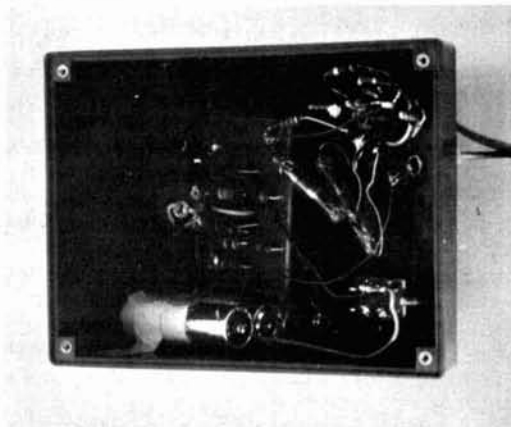

FOR THAT

"Extra Class"
YOU NEED THE



Listen for the hundreds of LK-2000 linears now on the air and judge for yourself. Write for free illustrated brochure or send \$1.00 for technical and instruction manual.

**BTI LK-2000
LINEAR
AMPLIFIER**

For SSB, CW, RTTY
Maximum legal input
Full loading 80-10M
Rugged Eimac 3-1000Z
Dependable operation
Easy to load and tune
No flat topping with ALC
Distinguished console
Instant transmit
High efficiency circuit
Designed for safety
Fast band switching
Real signal impact

Price . . . \$795⁰⁰
READY TO OPERATE!

BTI AMATEUR DIVISION

Hafstrom Technical Products

4616 Santa Fe, San Diego, Ca. 92109



"Your Friendly Supplier"

FROM STOCK!
OFFERS

A COMPLETE SELECTION OF ANTENNAS AND BEAMS: BOTH FIXED STATION & MOBILE, PLUS ALL ACCESSORIES . . .

Cushcraft

hy-gain

HI-PAR

Mosley

Webster

NEW-TRONIGS

SWANTENNA
BY SWAN

antenna
specialists

W2AU QUADS

W2AU BALUNS

WE ALSO HANDLE
Tristao CRANK-UP TOWERS

CHECK WITH US FOR YOUR REQUIREMENTS!

TIME PAYMENT PLAN AVAILABLE

WE MAINTAIN THE LARGEST STOCK OF USED EQUIPMENT IN THE NORTHEAST
WRITE FOR LATEST COMPLETE LIST

OPEN HOUSE SEPT. 14th, 1968

Evans RADIO

BOX 893

CONCORD NH 03301

FONE 603-225-3358

meaningful results above 200 kHz, you have to match the generator and the volt-meter.

In this circuit, the emitter and base-bias resistors are larger than in the previous design. This was done to reduce standing current; the large quiescent current previously used was suitable for a 1-mA movement. For an even more sensitive movement (say 50 μ A), the circuit resistances could be increased further.

For applications requiring low input resistance or impedance such as bridge-null indications, the transistor voltmeter can be preceded by a balanced common-base preamplifier.

table 1. Meter deflection for the circuit shown in fig. 3.

input volts	scale deflections	
	dc	rms ac
0	0	0
0.1	25.2	11.0
0.2	50.3	23.6
0.3	75.0	36.0
0.4	99.0	48.6
0.5		61.0
0.6		73.4
0.7		86.2
0.8		98.8

D. K. Madden, of Hobart, Tasmania, has modified this design slightly for use as a null indicator. He used the meter protection system shown in fig. 4 for desensitization when the bridge was far from null. The resistor was

fig. 4. Meter protection circuit.

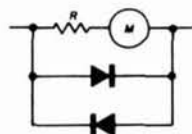

chosen to limit the meter reading to an on-scale value regardless of the input overload. Because of the nonlinear characteristic of the diode, this maneuver didn't affect the sensitivity of the instrument near zero where it was needed.

reference

1. R. S. Maddever, "An Improved Transistor Voltmeter and its Applications," *ham radio*, April, 1968, p. 74.

ham radio

Introducing



a **new** monthly
for amateurs

that's **different** *

- the latest in technical ideas and home construction . . .
- featuring **Jim Fisk**, W1DTY, the well known amateur radio editor . . .
- and including articles by your favorite authors.

how different? — *

It looks different — it is different! It's easier to find information . . . easier to read . . . easier to understand . . . easier to build from . . . it's a magazine you'll find it easy to like.

Write for **FREE** copy . . . or

One year for **\$5.00** . . . or

Get **ONE YEAR FREE** — 3 years for **\$10.00**

to Ham Radio Magazine, Greenville, New Hampshire 03048. Be sure to include your name, address, call and Zip code.

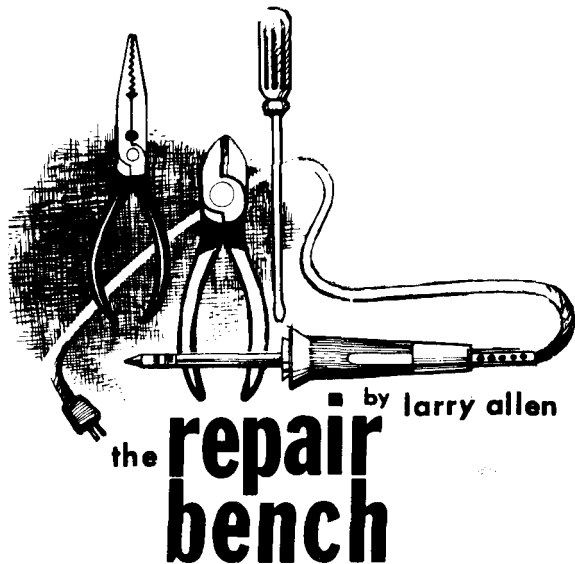

troubleshooting transistor ham gear

Hardly a month goes by that someone doesn't introduce new ham transistor equipment. It's about time we included some transistor troubleshooting information in this column. There are plenty of books on the subject, but it can't hurt to recap briefly some of the more fundamental transistor troubleshooting principles.

First of all, you should understand what a transistor does. In its most common use, a transistor is simply an amplifying device. For all practical purposes, you can see a transistor as a device through which controllable current flows. There are two kinds. In one, current flows from collector to emitter; in the other, from emitter to collector.

In either case, it is sufficient in this preliminary explanation for you to know that current in the transistor flows between these two elements. The phenomenon of amplification takes place because the transistor has a third element—called the **base**—that can control this flow of current.

Take a look at **fig. 1A**. This will acquaint you with the schematic diagram of a PNP transistor, one of the two types (the other is called an NPN). A transistor needs dc operating voltages. For a PNP transistor, they are applied as shown in **fig. 1A**. The emitter is usually grounded or connected to ground through a low-value resistor. Ground is therefore the common connection for all supply voltages.

The collector of a PNP transistor is connected to a strong negative voltage. This alone does not cause a flow of current in a normal transistor, but the possibility is there. It remains for **forward bias** to be applied to the base before collector current can flow. To cause normal current flow in this PNP transistor, a small negative voltage must be applied to the base. This makes the base more negative than the emitter (though still much less negative than the collector). With negative voltage applied to the base of a PNP transistor, the base-emitter junction is said to be **forward** biased, because the current flows easily across the junction from the N-material of the base to the P-material of the emitter. This base current is small, but it releases a large current flow between emitter and collector.

A small current in the base circuit controls a large current in the collector circuit; thus amplification is possible. Suppose a transistor, connected as in **fig. 1A**, has a small audio voltage applied to the base along with the forward dc bias. What the audio voltage does is increase and decrease the bias, which in turn lets more and less collector current flow. Therefore, a tiny sig-

fig. 1. Power-supply connections for typical transistors: the PNP takes negative on collector and base (A), the NPN, positive on collector and base.

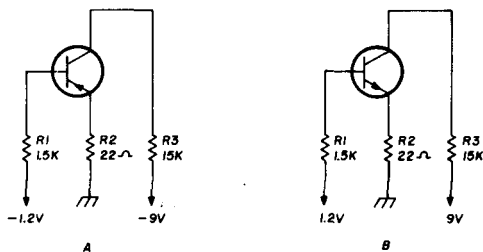

nal voltage or current in the base-emitter junction controls large amounts of signal current in the collector circuit. All you have to do is place a load resistor in the collector circuit and the current is converted to a strong voltage, and you have voltage amplification.

Fig. 1B shows the power supply connection for an NPN transistor. The collector of this transistor type is connected to a posi-

tive voltage. So is the base, but to a lower voltage. Again, any varying voltage, such as an af or rf signal, applied to the base will control the flow of current in the emitter-collector circuit.

Amplification is thus accomplished by either type of transistor; the only difference is in the polarity of dc power-supply voltages applied to operate the transistor. **Figs. 2A** and **2B** show both types of transistor connected in normal amplifying circuits. **Fig. 2A**, using the PNP, is an audio amplifier, as you can see from the values of components. **Fig. 2B**, using an NPN, is an rf amplifier, which you can see from the tuned air-core transformers used to couple the sig-

in, and are not easy to get loose for out-of-circuit testing. As a result, it is better to be able to **interpret** incorrect voltages. It really isn't too difficult, if you stop to **analyze the direction of current flow** in the transistor, whatever is polarity.

Remember that current always flows from the negative power-supply terminal toward the positive one. Therefore, if the collector of a PNP transistor is connected to negative voltage, it can mean only one thing: current in that transistor flows from collector to emitter. Conversely, if you're dealing with an NPN transistor, the collector is positive, and the direction of current flow is from emitter toward collector.

fig. 2. Use of the transistor in typical circuits: PNP in an audio circuit (A), NPN in an rf circuit (B).

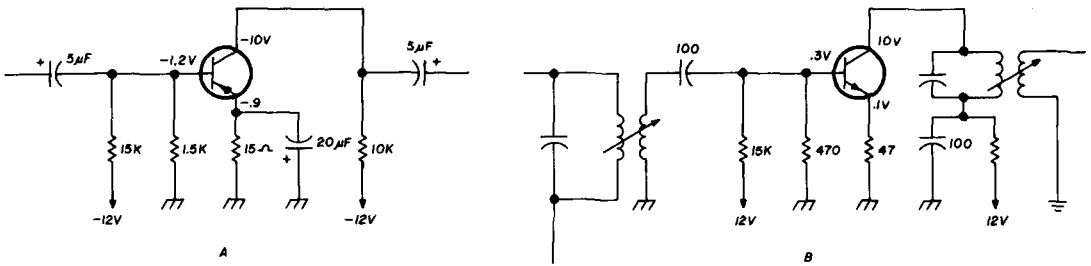

nal in and out. Either polarity of transistor could be used in either circuit, merely by reversing polarity of the power-supply connections.

Normal operating voltages are shown in both schematics of **fig. 2**, as they would appear in a diagram of equipment you might want to troubleshoot. The "fun" of troubleshooting starts when the dc operating voltages on a transistor have changed from normal. One may be high and another low; one may be okay while another is way off; or they may all be wrong. Whatever discrepancy you find in measuring dc voltages at the elements of a transistor, your problem is to figure out what's causing it. The transistor itself could be at fault, or there could be a problem in one of the other parts.

One way to find out if the transistor is faulty would be to remove it from the circuit and check it either with a tester or with your ohmmeter. (I'll tell you how to use your ohmmeter for a quick test later.) The trouble is that most transistors are soldered

In most cases, however, knowing the direction of flow is not really as important as figuring out whether the voltage at the collector has increased or decreased. If it has increased—that is, if it's **closer** to the power supply voltage—you can reason quite easily that there must be less current flowing through the load resistor and consequently less voltage drop across it. Since the load resistor is in series with the collector circuit, it stands to reason that less current is flowing through the transistor, too.

If the power-supply voltage is negative, say -12 volts, the normal collector voltage may be about -10 volts. Suppose when you measure the voltage you find it to be -11.6 on the collector. This can mean only one thing: there is less collector current, signified by less **drop** across the load resistor. You can also be sure the cause is not the load resistor having increased in value, because that would cause a larger voltage drop and the voltage at the collector would be **less** than the normal -10 volts.

Exactly the same reasoning follows if you're dealing with an NPN transistor, where the collector voltage is positive. If the collector voltage shifts nearer to the power-supply voltage, whatever its polarity, it is a sign of reduced collector current. There is an outside possibility that the load resistor has lowered in value and therefore does not drop as much voltage. In that case, collector current would be unusually high, yet you'd still find a higher voltage at the collector. This seldom happens.

How many things can cause abnormal collector voltage? Or, phrased another way, depending on your conclusion from the first collector-voltage measurement, what makes a transistor draw less current than normal?

Two things: a faulty transistor, or reduced bias voltage (which causes reduced bias current). The way to find out which is to measure the bias voltage. If it is much lower than it should be, then chances are the bias voltage is the cause of reduced current; the transistor may be okay. If bias is normal, yet current is very low through the transistor, the transistor is probably defective.

Once you suspect by this method of reasoning that the transistor is okay, you might as well go ahead and check the other parts. Measure resistors to see if they've

fig. 3. Using ohmmeter readings to check the quality of a transistor. Both types should show high readings in both directions between the emitter and collector terminals.

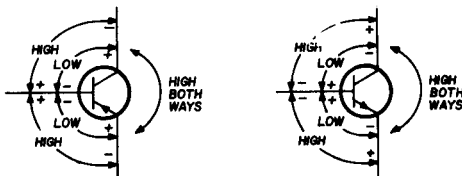

changed value, and check capacitors to see if they are leaky. Your ohmmeter is handy for both these tests.

If you decide to suspect the transistor, there are a couple more checks you can make before you disconnect the transistor for external testing. Clip your voltmeter—

across the collector terminal and the emitter terminal. This is the best way to measure collector voltage. If it reads at least slightly below the power-supply voltage it is connected to, proceed with this test. With a jumper lead, short the **base** of the transistor to the **emitter**. CAUTION: Be sure it is the emitter you short the base to; if you short it to the collector, you'll burn up the transistor. Watch the collector voltage as you make the jumper connection. If the transistor is operating normally, the collector voltage will jump upward, and read virtually the same as its power-supply source. If it doesn't, either the base element is open inside the transistor or the collector junction is leaky. Either condition signifies a defective transistor.

Now let's go back and see what we'd have done if the voltage on the collector were too low. Again keep in mind that this depends not at all on which polarity of transistor is involved; just consider "higher" voltage as being **closer to** the supply value and "lower" as being **further from** the supply value.

If the voltage at the collector is low, it means that either the load resistor has increased in value (unlikely) or more current is being drawn through it. If the latter, then more current than normal is flowing in the transistor collector. This in turn may be caused either by a faulty transistor that allows too much current to flow, or by too much bias current flowing between base and emitter.

Your voltmeter will tell you whether the bias voltage is too high. If it is, track down the trouble in the resistive network that develops the bias. You'll find any of several different resistor arrangements, but all of them are simple voltage dividers. You should have no trouble checking the resistors with your ohmmeter.

If bias is okay, the trouble is likely inside the transistor. Either it is leaky, allowing too much current to flow, or some trouble in the base-emitter junction is not letting the bias control the transistor as it should. Again, you can make the "jumper" test mentioned earlier: while measuring the collector voltage, connect the base terminal to the emitter terminal. The abnormally low voltage at the collector should suddenly jump up to the power-

supply voltage. If it doesn't, the base circuit is not controlling collector current as it should. With zero bias, which is what you have when you short the base to the emitter, very little collector current should flow—only as much as is permitted by leakage in the transistor. With almost no collector current flowing, the collector voltage should be almost the same

fig. 4. Wide spacing of the collector lead is one clue to finding connections. The metal case of a flange-mounted power transistor is usually the collector connection. There are other configurations, but these are the most common.

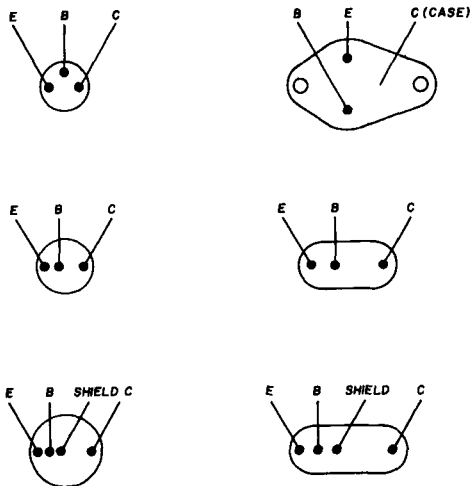

NOTE: SPOT OF RED PAINT IS OFTEN USED TO IDENTIFY COLLECTOR

as the voltage at the source end of the load resistor (no drop across the resistor).

Finally, suppose you've decided the transistor is faulty and you want a final double-check. You can get that with your ohmmeter. A transistor tester is handy, but your ohmmeter is adequate if you know how to use it. The secret of checking transistors with an ohmmeter lies in measuring the backward and forward resistances of the junctions in the transistor. What you should find is shown in **figs. 3A and 3B**. A PNP transistor is shown at **A** and an NPN transistor at **B**. As indicated by the diagrams, the ratios of forward-to-backward resistances are more important than any specific values. The readings in one direction must be much higher than in the other. For

small-signal transistors (they are physically small, too), the ratio should be 500:1 or better. In power transistors (the large ones with metal flanges), the ratio can be as low as 100:1, and occasionally even lower. When you're in doubt, check the readings of a suspected transistor against a new one of a similar type.

The mechanics of the test are simple. Connect the ground lead of your ohmmeter to the base; then with the other ohmmeter lead, check the reading from base to emitter and then from base to collector. Reverse the leads by touching the probe to the base and use the ground lead to check first the emitter and then the collector. If you use a small chart like those in **fig. 3**, which you can draw on any scrap of paper, you can jot down the readings and then compare them. This test method applies to either NPN or PNP, although the highs and lows are exactly opposite. Nevertheless, **ratio** is what is important; in either type of transistor, the ratios should be high.

To wind up this month's column on "quickie" transistor troubleshooting, I've included some base diagrams of several common transistor types in **fig. 4**. You'll find them easy to memorize, but you can also sketch them on a piece of cardboard and post them on the wall of your shack or on the back of your workbench.

Rarely will you find a transistor that varies from those shown in the diagrams. If you happen to have a piece of equipment with one that does vary, the manufacturer's service data that comes with the unit will show the proper lead configuration. Be very sure you are using the *right* configuration, particularly when you make the base-emitter "jumper" test. Remember, shorting the base to the collector, even accidentally, can ruin the transistor.

It is obviously impossible to cover all transistor troubleshooting possibilities in one short column. However, if you have specific questions about troubleshooting transistor equipment, drop me a line. Or, if you use some special technique in tracking down trouble in your own transistor gear, tell me about that. I'll use some of the more interesting and helpful ideas in future columns.

ham radio

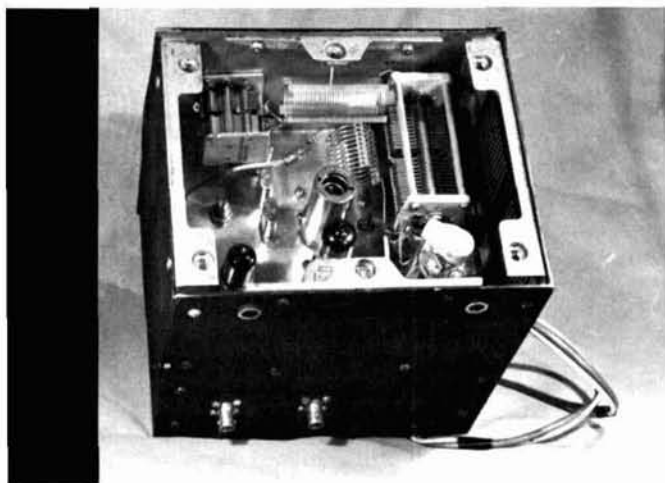

high-level high-frequency transverter

The megahertz mover—
a simple method
for extending
the frequency coverage
of ssb transceivers

John Stanley, K4ERO, 1501 Robin Road, Maryville, Tennessee

Some amateurs are still using a-m on the MARS frequencies and ham bands because their gear only covers one band; many old sideband rigs get dusty on the shelf because they don't cover 15 or 10 meters. Recently, Heathkit recognized the demand for multi-band operation and added an all-band rig to the low-priced HW series of transceivers (the HW-100).

The **megahertz mover** will make the limited-coverage rig as versatile as the builder wants. I use the unit described here to put a HW-32 on 75, 40 and 15 meters, but you can use it on any frequency between 2 and 30 MHz with a simple crystal and coil change.

For those of you who tend to shy away from ssb homebrewing, let me point out that the **megahertz mover** is not any more exotic than a receiving-type mixer or single-tube linear amplifier. There are no balanced modulators, sideband filters, or phase-shift networks; all of the complex circuits are in the basic transceiver. In addition, tuneup is simple and requires no special test equipment.

High-level transverting is not new. It's been

used to put ssb on the vhf bands for years, and has even seen some use on the lower bands.¹ However, the full potential of this approach has not been used. Take a look at the schematic and see if this isn't the way for you to put a high-quality ssb signal on a new frequency with a minimum outlay of time and green stuff.

the circuit

The transmitting mixer consists of a screen driven 5763, driven with reduced transceiver output. Output can be reduced several ways. I run my HW-32 with reduced plate voltage and with the audio gain turned down. If you are a purist for linearity and carrier suppression, you can use an attenuating network. However, scope and on-the-air testing indicate the method I use produces excellent results—with a saving in dc input power.

The output of the 6CL6 oscillator-multiplier is coupled into the 5763 grid. The exact frequencies involved depend on the transceiver you use and the frequency coverage you want. I used crystals on 10.350, 10.750 and 11.866 MHz to provide coverage of the top

Layout of the megahertz mover. The loading capacitor is in the lower left, the tuning capacitor at the upper left; two of the crystals can be seen in the foreground.

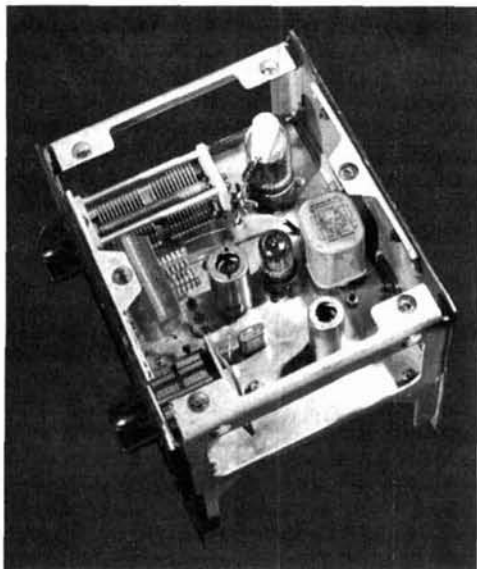

150 kHz on 75, 40 and 15 meters respectively. To cover the MARS channels on the low end of 40 meters without retuning, plug in a 10.650-MHz crystal.

The 6146 final amplifier is operated in class AB₁ and uses the output circuit popularized by the "Sideband Package".² This avoids any bandswitching in the final. If you have enough contacts available on the bandswitch of course, you can use a conventional pi network.

The receiver section of the transverter consists of a simple 6BE6 converter. This has proven satisfactory up through 15 meters, al-

fig. 1. Block diagram of the megahertz mover.

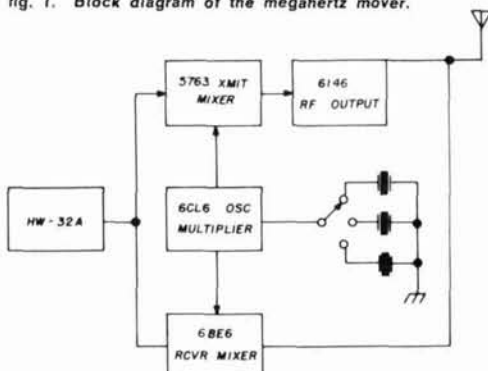

though a good rf amplifier might be useful if 10-meter coverage is desired. The rf stage would improve noise figure and sensitivity on the higher frequencies; on the lower bands, the extra gain would be detrimental to overall performance.

Since the input to the receiver grid is picked off the final tank circuit, peaking the receiver for a given frequency automatically tunes the final. Bandchanging entails throwing the bandswitch to the desired band and peaking the final and loading capacitors— instant QSY!

mechanical considerations

Parts layout is not critical. I used a surplus cabinet because I found one about the right size. An aluminum box about eight inches on each side provides adequate space. Some of you home-brewers who are gung-ho for miniaturization could get it in half the space. The only front panel controls are the bandswitch, plate tuning and antenna loading. I also used a surplus relay, but there are many

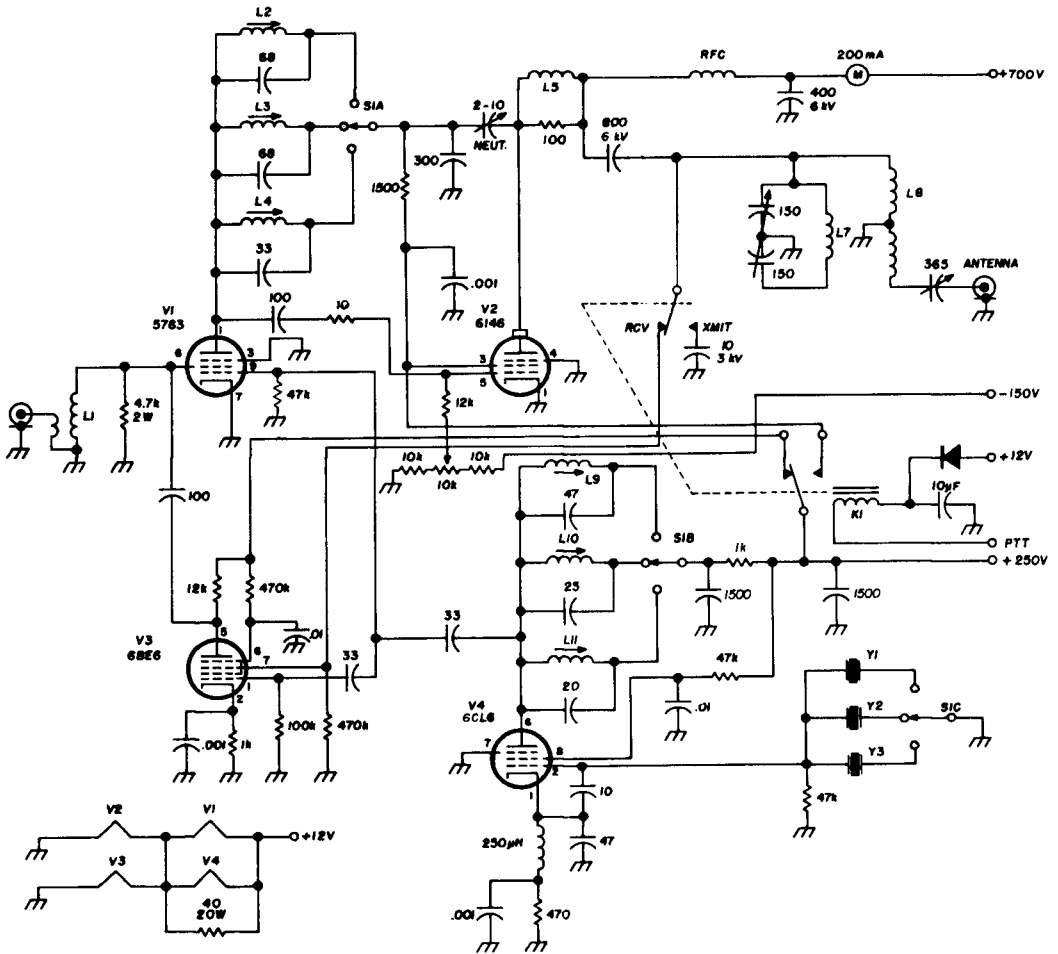

K1 12-volt DPDT relay

L1 Resonate to 14 MHz with tube in socket. Input link is $\frac{1}{4}$ turn number 18.

L2 4 MHz. 90 turns number 34 on $\frac{1}{4}$ " diameter slug-tuned coil form.

L3 7 MHz. 20 turns number 26 on $\frac{1}{4}$ " diameter slug-tuned coil form.

L4 21 MHz. 9 turns number 22 on $\frac{1}{4}$ " diameter slug-tuned coil form.

L5 4 turns number 18 on a 100-ohm, 2-watt resistor.

L7 9 turns number 18, 1" diameter, 8 TPI (B&W 3014).

L8 21 turns number 20, 1" diameter, 16 TPI (B&W 3015). Link is 14 turns of same on cold end.

L9 10 MHz. 20 turns number 24 on $\frac{1}{4}$ " diameter slug-tuned coil form.

L10 20 MHz. 8 turns number 22 on $\frac{1}{4}$ " diameter slug-tuned coil form.

L11 35.6 MHz. 6 turns number 22 on $\frac{1}{4}$ " diameter slug-tuned coil form.

S1 3 pole, 3 position rotary switch.

Y1 10.35-MHz crystal

Y2 10.750-MHz crystal

Y3 11.866-MHz crystal

fig. 2. Schematic diagram of the megahertz mover—a high-level transverter that may be used on any frequency between 2 and 30 MHz with the proper crystal and coil changes. The unit is shown here for 3.5, 7 and 21 MHz output with 14-MHz drive.

commercial equivalents. On the rear of the cabinet are two BNC connectors (antenna and transceiver), the bias pot and the power cable.

power supply

In most cases, the voltages for operating the **megahertz mover** can be taken from the transceiver supply. If you have any doubt about the capacity of your supply, a separate supply providing 12 volts at 1.5 amps and 250

Below chassis construction of the megahertz mover.

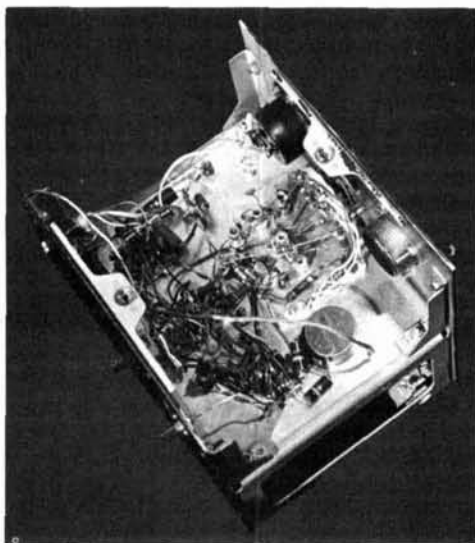

volts at 100 mA should be used. The bias voltage from the transceiver supply can be used in almost every case.

If you lower the plate voltage or current in the transceiver when using the **megahertz mover**, the high-voltage supply can also be used for the 6146. If you want, you can add a power switch to the transceiver power supply so you can switch instantly from transvert to straight-through operation.

tune-up

To put the transverter into operation, all you have to do is peak the coils. First, adjust L1 for resonance with a grid-dip meter or by listening to signals coming through the unit. Tune the final to peak the receiver; then

peak the oscillator-multiplier for the band being used.

After the receiver is tuned up, go to transmit and set the bias for about 15 mA of plate current. Then apply a test tone, preferably a two-tone, to the mike input and feed the output into a dummy load. Tune the driver coil for maximum output. The final should already be tuned from the receiver tune up. Neutralization follows standard procedure. Finally, peak up all the coils, especially the oscillator-multiplier coils, and check linearity with a scope.

general considerations

I used the 20-meter Heathkit HW-32 for coverage on 75, 40 and 15 meters. If you use another transceiver to cover some other frequency range, you'll have to work out the crystal frequencies. When doing this, there are several factors you should keep in mind:

1. In general, it's better to use a mixing frequency above the band you want to prevent birdies caused by crystal harmonics. You'll notice that I mix 10 MHz with 14 MHz to reach 4 MHz rather than using a 6-MHz crystal/tripler: 21 MHz injection is used for the 7 MHz range and a 35-MHz signal for the 21-MHz band. In the latter case it's quite obvious if a 7-MHz crystal were used with a 14-MHz transceiver to cover the 15-meter band, you'd have a lot of trouble with birdies.

2. Because of the birdie and doubling problem, you can't cover a band that is an exact multiple of the band you start with. I couldn't cover 28 MHz with the 14-MHz HW-32 because the second harmonic of 14 MHz would give me an extra signal on 28 MHz.

(Experimentally-minded amateurs might try it by using a carefully designed balanced or hybrid modulator.)

3. If your transceiver only has one sideband, use extra care when you mix frequencies, because some combinations switch the sideband. If the mix frequency is above the transceiver frequency and resultant frequency, the sideband will be reversed; other-

the permaflex key

- both a twin lever & straight hand key in a pivotless 2 paddle design.
- gives instant choice of automatic semi-automatic & straight hand keying.
- use directly with any transmitter or through an electronic keyer.
- 8 amp. gold diffused silver contacts adjust from 0-.060" & 5-50 grams.
- distinctive blue paddles are of rugged G-10 fiberglass epoxy.
- cabinet is 16 gauge polished chrome steel: 1.95" sq. x 3.75", paddles extend 1.25", weight app. 1 pound.
- silicone rubber feet for stability.
- 100% US made & guaranteed for 1 yr.



1995 complete,
ppd. u.s.a
send cert. ck. or m. o.
n. y. res. add 5% tax

the James research company
11 schermehorn st., brooklyn n.y. 11201

BUILD YOUR AMATEUR RADIO LIBRARY

See Page 85



36th W-I-M-U HAMFEST

WYOMING · IDAHO · MONTANA · UTAH

Mack's Inn, Idaho

August 2, 3, 4, 1968

"A resort community, adjacent to National Forest Campground, on Hwy #191, 23 miles SW of West Yellowstone, Montana, and 24 miles from the Park."

For details write W7WYG

WIMU Hamfest

3100 6th AVENUE, SOUTH

GREAT FALLS, MONTANA 59401

table 1. Crystal mixing frequencies.

transceiver freq	output-freq	mixer freq
14 MHz USB	4 MHz USB	10 MHz
14 MHz USB	4 MHz LSB	18 MHz
14 MHz USB	7 MHz LSB	21 MHz
14 MHz USB	21 MHz LSB	35 MHz
14 MHz	any MARS frequency	frequency ± 14 MHz
7 MHz LSB	4 MHz USB	13 MHz
7 MHz LSB	4 MHz LSB	3 MHz
7 MHz	any MARS frequency	frequency $+ 7$ MHz
4 MHz LSB	7 MHz USB	13 MHz
4 MHz LSB	7 MHz LSB	3 MHz
4 MHz LSB	14 MHz USB	18 MHz
4 MHz LSB	21 MHz USB	25 MHz
4 MHz LSB	28 MHz USB	32 MHz
4 MHz LSB	50 MHz USB	54 MHz
4 MHz	any MARS frequency	frequency $+ 4$ MHz
50 MHz USB	4 MHz LSB	54 MHz
50 MHz USB	7 MHz LSB	57 MHz
50 MHz USB	any frequency LSB	frequency $+ 50$ MHz

Exact frequencies are not given since they must be calculated for each particular situation and depend upon the frequency range of the transceiver and the coverage desired. Note that on some bands the dial calibration as well as the sideband is reversed.

wise, the output from the transverter will be the same as the transceiver. This consideration may over-ride number 1 above. It's better to have a slight birdie in the receiver than to be on the wrong sideband. A table of suggested frequencies is worked out in table 1.

I have used the megahertz mover for nearly a year and have had excellent reports on all bands; the quality is essentially that of the transceiver. Power output is down slightly from the 200 watts PEP of the HW-32, but not enough to affect performance. If you are a power nut, put a pair of 6146's in the unit or drive a big tube.

References

1. "High-Level Converters," *SSB for the Radio Amateur*, ARRL, 3rd Edition, 1962, p. 196.
2. G. K. Bigler, W6TEU, "A Sideband Package," *QST*, June, 1958, p. 24.

ham radio



Hello there. My name is Romey and I'm here to give you a preview of STELLAR'S **Suitcase Station**. It's just in the experimental stage now, but if you hams want it and will tell me what features you'd like in it, we plan to make it available as a package at a later date. If you send me your ideas, I'll see that you get a merchandise certificate for each one we use. Write me at Department H for further information. 73 es 88.



stellar industries
DIV. OF STELLAR I, INC.
SALES AND SERVICE

ELECTRONIC COMMUNICATIONS EQUIPMENT

10 GRAHAM ROAD WEST
ITHACA, N. Y. 14850
TELEPHONE: AREA CODE 607 273-9333

Your headquarters in Central New York for
new and used ham gear—sales and service.
Mail orders welcomed.

Hours: 9:00 A.M. to 5:30 P.M. Monday through Friday 9:00 A.M. to 5:00 P.M. Saturday

IMPORTANT ANNOUNCEMENT

ALL VANGUARD CONVERTERS NOW USE
R C A DUAL GATE MOSFETS
FOR BOTH THE RF AND MIXER STAGES

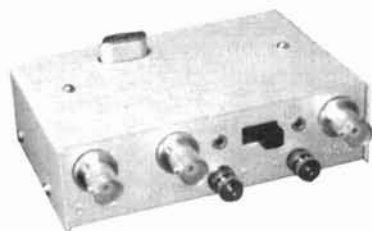

prices start at \$26.95

The performance and features of our new converters are so spectacular that they can only be fully described in our new illustrated catalog which is available **FREE**. Send for it today and see our entire line of converters, pre-amps and other communications equipment.

VANGUARD now makes the best converters. Buy one and be convinced.

VANGUARD LABS 196-23 Jamaica Ave. Dept. R
Hollis, N.Y. 11423

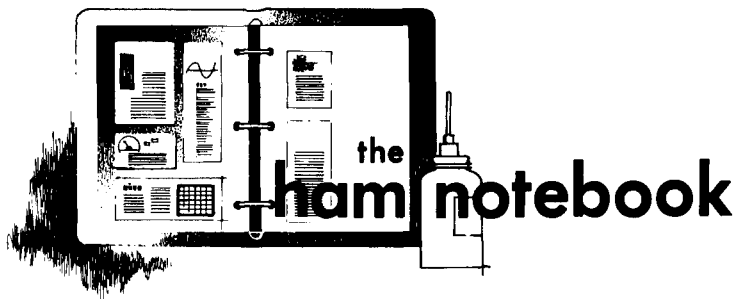

six-meter tunnel-diode phone rig

Those of you who would like to try your hand at flea-power tunnel-diode hamming should get a big kick out of the rig shown in **fig. 1**. With a tunnel diode, the little transmitter can be built into the tiniest housing, yet still provide adequate rf output to make local contacts.

L1 consists of 4 turns of number -16 copper wire spaced 5/8" and wound 5/8" in diameter. L2 is the coupling to the antenna and can be a 1- or 2-turn link. Use a 26-MHz third-overtone type crystal.

To tune up the flea-power rig, hook a VOM across the 150-ohm pot and adjust for minimum resistance. Now, apply power to the

transmitter and slowly advance the pot until oscillation occurs—at approximately 0.20 volts. At a bias voltage of 0.18, you'll notice a slight voltage upsurge which corresponds to an audible blast from a monitor receiver tuned to the transmit frequency. Adjust so that the TD stops breaking in and out of oscillation—at this point place a shaft lock on it. Tune the 45-pF variable for maximum output. Hook on a carbon microphone, and you're ready to give out your first CQ.

Bob Brown, K2ZSQ/W9HBF

10-minute timer from a Heathkit CA-1

A lot of amateurs have an old Heathkit CA-1 Conelrad alarm laying around that they don't need any more. Here's a way to convert it to a handy ten-minute timer with a diode, a capacitor, a resistor and a 6AK5. For the conversion, remove the chassis from the cabinet—you'll find a two-lug terminal strip near the ac line cord. Unsolder the resistor going to pin 1 of the tube socket and remove the terminal strip, resistor, rubber grommet and shielded cable.

Install a new terminal strip, connect the cathode end of a 500-mA, 400-PIV silicon diode to the anode of the old diode and the other end (anode) to the new terminal strip. Run a wire from the other lug on the terminal strip to pin 1 of the tube socket and connect a 20- μ F capacitor between pin 1 and ground (positive to ground). Also connect a 4.2-meg-

fig. 1. Simple six-meter TD transmitter. Crystal is a 26-MHz overtone type; output can be coupled to any 50-ohm coaxial line. The battery is a 1.35 Vdc hearing-aid type. D1 is a tunnel diode such as the 1N3714.

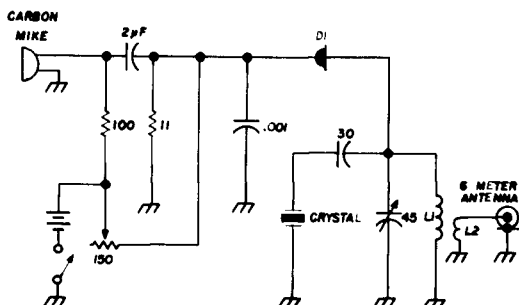

ohm resistor between pin 1 and ground.

Now, take both wires off the pushbutton switch and short them together. If you want, you can remove the short wire completely and connect the long wire directly to the relay—this accomplishes the same thing.

Connect two new wires to the normally-open contacts on the switch and run them through a grommet to the two lugs on the new terminal strip. Rewire the tube socket to accommodate the 6AK5; this is a simple exchange of the wires going to pins 5 and 6 on the socket; make sure that pin five is not shorted to pin seven. The diagram in fig. 2 shows all the details. This completes the conversion.

Turn the unit on. After it warms up a bit, the 6AK5 will turn on, pick up the relay and turn on the light. Push the switch. This applies -150 volts to the grid of the 6AK5 and turns it off—it also charges the 20- μ F capacitor. When the capacitor is discharged by the 4.2-megohm resistor, the 6AK5 will turn on again and pick up the relay; this should take about ten minutes. You can make fine tuning adjustments by adjusting the tension on the armature spring on the relay. The ac socket on the front panel can be used as a power source to ring a bell or turn on another light; just replace the fuse with an appropriate value. My unit is timed at 9 minutes, 45 seconds; this gives me plenty of time to identify. I've used it for over a year and it hasn't changed a second.

Harold Mohr, K8ZHZ

fig. 2. Original Heathkit Conelrad Monitor circuit and its conversion to a 10-minute timer.

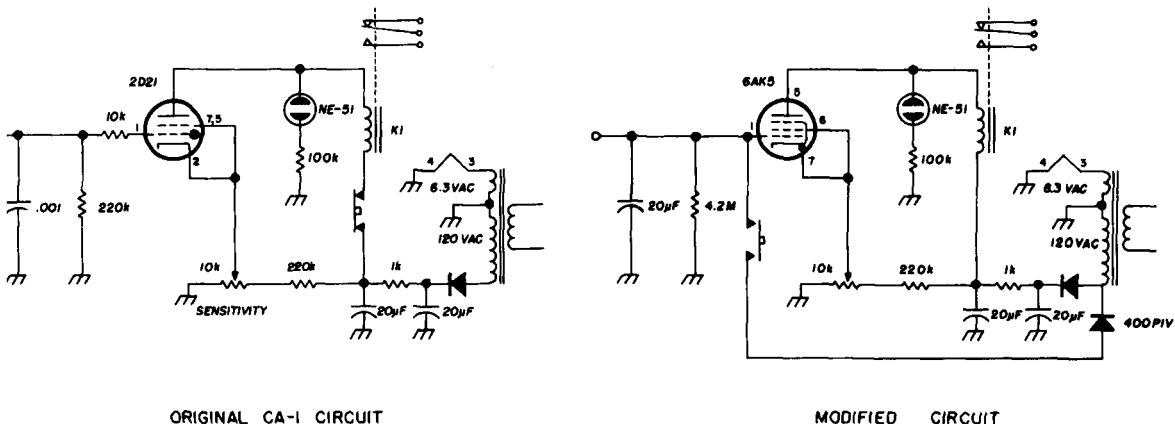

line transient protection

If you're troubled with line transients blowing out solid-state components, fig. 3 shows a simple protective circuit that will tame down the voltage spikes on the line. In this circuit, the two capacitors are charged to the normal repetitive peak reverse voltage; the diodes shunt short-duration transients to the RC filters. The circuit constants shown are for 117-Vac lines. For 220-volt lines, double the voltage ratings of the diodes and capacitors and change the resistors to 200k ohms.

Jim Fisk, W1DTY

fig. 3. Simple circuit for suppressing voltage transients on the ac line.

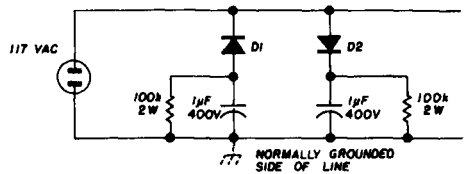

D1, D2 = 1000-PIV SILICON DIODES

deburring holes

A large drill, at least three times the hole diameter, may be used for rapid deburring. Place the drill in a drill press, and bring each raw hole against it briefly. Be careful to use well-sharpened drill bits when working with brass and plastics.

W2DXH

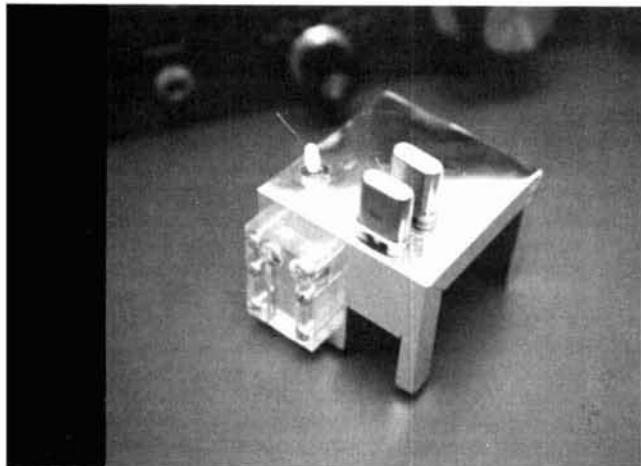

rtty reception with the SB-300

Here's a way
to receive RTTY
on the Heathkit SB-300
without any modifications

Maury Cox, W2ARZ, 3716 Frazier Road, Endwell, New York 13760

If you own a Heathkit SB-300 and are interested in RTTY reception, here is a handy-dandy little **gizmo** that effectively makes it into a model 301 as far as RTTY is concerned. What's more, no modification to the basic receiver is necessary.

Installation of the RTTY adapter in the SB-300 receiver.

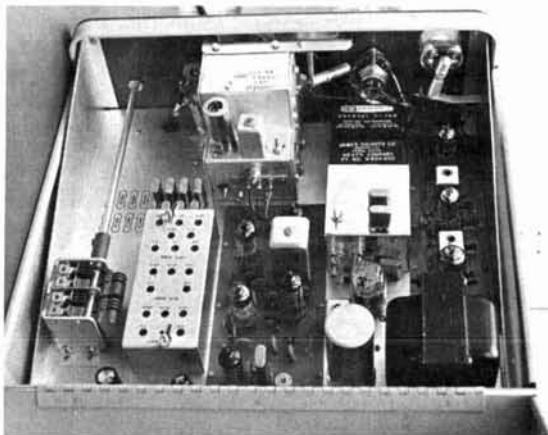

The **gizmo** is an inexpensive adapter that is almost easier to build than to describe. It provides a means of switching (in USB mode) between the upper-sideband crystal and an added RTTY crystal in the bfo. The additional crystal puts the 850-Hz RTTY signal (differ-

fig. 1. Layout of aluminum sheet used to make up the RTTY adapter chassis.

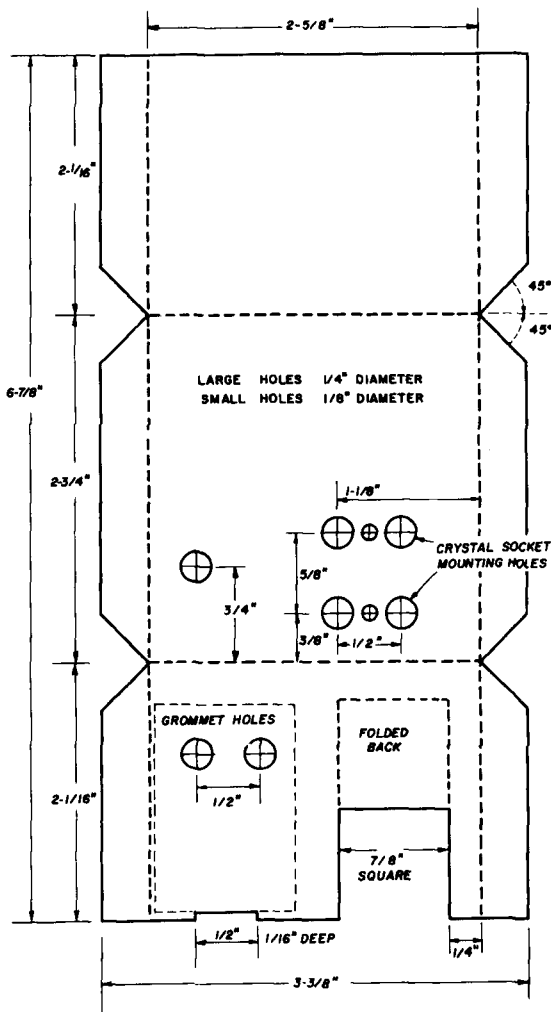

ence between the mark, 2125, and space, 2975) within the bandpass of the ssb filter. You can buy the crystal you need from Heath*.

If you use the SB-300 with a transmitter for

transceive operation, a word of caution: the bfo amplifier (V9C) should be disabled or disconnected during reception to prevent accidental transceive operation. In the SB-301, pins 11 and 12 of mode switch (MS3R) disable the amplifier in the RTTY mode by removing B-plus from the plate of V9C. If you use independent transmit-receive operation, there's no problem, and you can forget the bfo amplifier.

The RTTY adapter is simply an open aluminum box with two crystal sockets, the upper-sideband and RTTY crystals, and a miniature toggle switch. A block of clear plastic holds two pieces of number 16 bus wire that simulate the crystal contact pins. The adapter fits over the crystal filter nearest the bfo crystals and plugs into the upper-sideband crystal socket. The upper-sideband and new RTTY crystal are plugged into the two sockets on top of the adapter. Installation of the RTTY adapter is clearly shown in the photograph.

construction

The adapter is made in two pieces, and construction is quite simple. The two pieces—the aluminum box and the plastic block—are bolted together, the wires connected, and that's all there is to it! Except for the 1/2-inch spacing between contact pins in the plastic block, there is nothing critical about any of the dimensions. Almost any available materials and hardware can be used.

To make the box, cut a rectangular piece of thin aluminum sheet 3-3/8-inches wide and 6-7/8 inches long as shown in **fig. 1**. Cut the four 90° corner notches and the 1/2- by 1/16-inch clearance notch at bottom. You may prefer to drill all the holes for mounting the hardware now, or you can wait until the box is formed into its finished shape. Just follow the hole layout shown in **fig. 1**. Not shown on the drawing are the four holes used to support the plastic block.

Make the box by folding the aluminum 90° along the dashed lines in **fig. 1**. Cut out the 7/8-inch square piece shown in **fig. 1**, or fold it back inside the box so the box doesn't interfere with the lower-sideband crystal when it's plugged in. Mount the two crystal sockets,

* Heath Company, Benton Harbor, Michigan 49022. 3392.110 kHz crystal, part number 404-280, \$5.00

toggle switch and two rubber grommets.

plastic block

Cut out a rectangular piece about 1-1/8-inches wide by 1-5/8-inches high from a piece of plastic about 5/16 inches thick. The plastic doesn't have to be clear, but if it is, it will be a big help. Drill two parallel holes on 1/2-inch centers to a depth of 1-3/16-inch as shown in

fig. 2. Wiring diagram of the RTTY adapter.

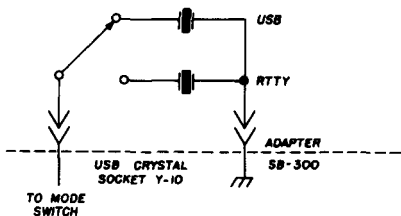

fig. 2. Locate these holes symmetrically with respect to the block centerlines. (Use a number-53 drill for number-16 tinned wire.)

Drill two 3/8-inch holes at right angles to the inner ends of these holes, so that the tip of the drill goes about 1/16-inch beyond the wire holes. These 3/8-holes clear the grommets on the side of the box; the 1/16-inch extra depth provides room for attaching the hookup wire to the wire "pins." Now drill four (or six, if desired) mounting holes. I used a number-33 drill for 4-40 screws.

Cut a couple of **straight** pieces of number-16 tinned wire about 1-3/4-inches long, and insert them **as far as they will go** into the wire holes. Remove about 3/8-inch of insulation from two 2-inch lengths of hook-up wire, loop one turn around the upper end of each of the tinned-wire pins, and solder. This completes the block.

Fig. 2 shows the details. This is the trickiest part of the whole operation because you're working in close quarters; a crochet needle or spring hook will prove invaluable at this point. Also, although there is no functional requirement for clear plastic, its transparency is a definite asset and helps construction.

assembly and wiring

Push the free ends of the two pieces of hook-up wire through the grommets, and bolt

the plastic blocks to the face of the aluminum box so the bottom of the block is flush with the top of the 1/16-inch notch. Connect the two wires to the crystals and switch as shown in fig. 3. Be sure to connect the common (ground) pins of the two crystal sockets in the RTTY adapter so that they are connected to the common pin of the upper-sideband crystal

fig. 3. Plug assembly which goes into the upper-sideband crystal socket of the SB-300.

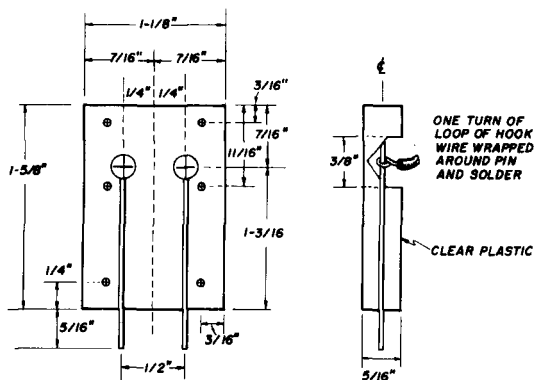

socket (Y-10) in the SB-300 when the adapter is in place.

You may also want to label the settings of the toggle switch on the adapter so you won't forget which is upper sideband and which is

fig. 4. The completed RTTY adapter for the SB-300.

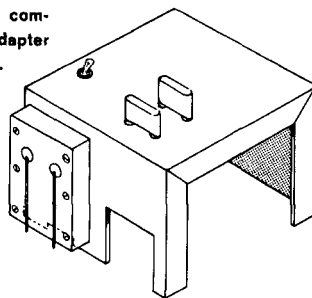

RTTY. Plug in the unit, and you're ready to go. This adapter, of course, does not eliminate the need for an RTTY terminal unit. The TU may be connected to either the speaker or anti-vox output jacks, depending upon the impedance that is required.

ham radio



NEW ...

'In Line'

WATTMETER

- * Measures absolute power with 1dB accuracy.
- * Operates at all frequencies from 1.5 to 60 MHz.
- * Calibrated 0.2 to 1500 watts in three ranges.
- * Doubles as VSWR meter without charts.

write for free data

COMDEL

beverly airport
beverly, mass. 01915

propagation predictions for july

High-frequency forecasts
for the month of July
plus some predictions
for multi-hop
sporadic-E
propagation on 6 meters

Victor R. Frank, WB6KAP, 12450 Skyline Boulevard, Woodside, California 94062

The primary emphasis of this column will be on long-haul high-frequency communications over distances greater than 2500 miles (4000 kilometers). Over paths of this length, hf communications are dependent upon the F2 layer. The predictions will be as general as possible—applicable to almost any situation that the DX'er will run into.

Basically, these predictions will try to answer two questions: is the band open, and how far? At first, the format for the predictions may seem unusual. However, with the graphical presentations I have used here, they are much more versatile than a tabular form. Also, the graphs provide some insight to the underlying causes of propagation (or lack of it) over a given path on a certain band. It also permits mental "fudging" to allow for day-to-day variations in ionospheric conditions and shows the affect of geographic latitude on the maximum usable frequency (MUF).

maximum usable frequency

The propagation predictions are in two parts. The first part shows the maximum usable frequency for various latitudes in the northern hemisphere. The maximum usable frequency in this case is defined as the highest frequency that will be returned to the earth by the F2 layer in a given direction. The distance at which the signal will be returned by a single hop is about 2500 miles or 4000 kilometers. The reflection point is in the middle of the first hop—about 2000 kilometers from the end. This point is called the **control point** because its MUF determines the highest propagating frequency in that particular direction by the F2 layer. Basically, then, for long-haul

communications, we're interested in the condition of the ionosphere about 2000 kilometers or 1200 miles away from the transmitter.

For communications over distances greater than 4000 kilometers by way of the F2 layer, a signal travels by successive hops between the earth and the ionosphere. If the MUF falls below the operating frequency, the signal may not be returned to earth, but will propagate by internal reflection in the ionosphere until it reaches a region where the MUF is high enough to return it to the earth. Therefore, there may be extended skip zones beyond the first hop—especially over the poles and temperate latitudes in advance of the dawn line.

These skip zones are not forecasted on the basis of a single control point. For any long path, there are two control points, 2000 kilometers in from each end. Each will have a MUF that depends on latitude and local time, and to some extent, longitude. The two-control-point method forecasts that the overall path MUF will be the **lesser** of the two control-point MUF's. There is some evidence

that during the summer months, sporadic-E propagation at the end of the path with the lowest MUF may raise the path MUF to the greater of the two control-point MUF's.

The MUF curves shown here are properly referred to as **MUF (4000) F2**. This simply means the maximum usable frequency at which the F2 layer will provide communications over a 4000-kilometer path. If you're confused by the use of kilometers, just remember that 4000 kilometers is approximately 2500 miles. Kilometers are used here because this is the standard nomenclature used in ionospheric propagation discussions and in propagation information available from the Institute of Telecommunications Sciences, Boulder, Colorado.

maximum possible range

The second part of the propagation predictions concerns the maximum possible range; this is determined by absorption. Absorption is a function of both the solar zenith angle and the angle of incidence at each penetration of the D layer, but will vary somewhat with atmospheric noise and the equipment

fig. 1. Maximum usable frequency curves for July 1968 based on 75° W longitude. For information on how to use these curves, refer to the box on page 84.

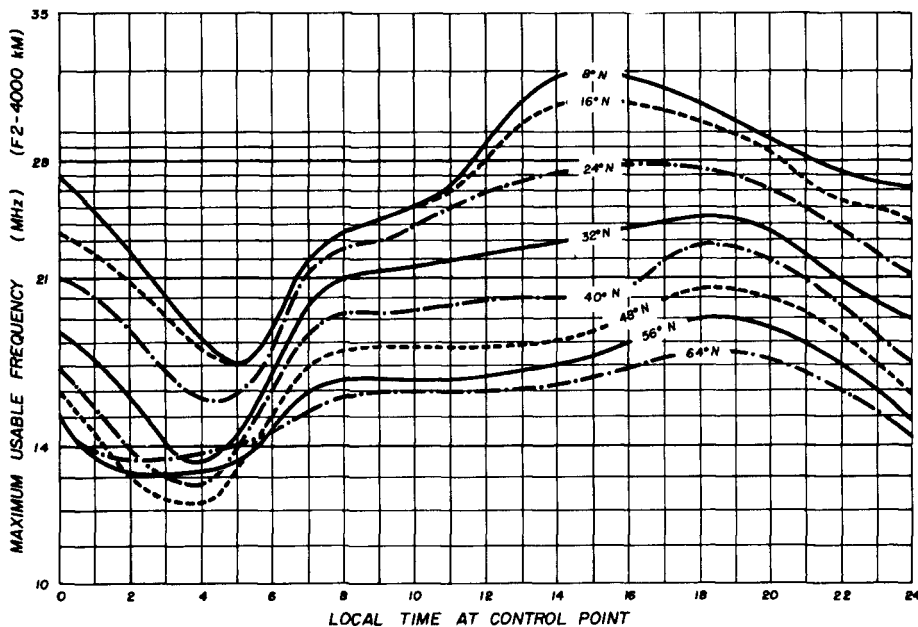

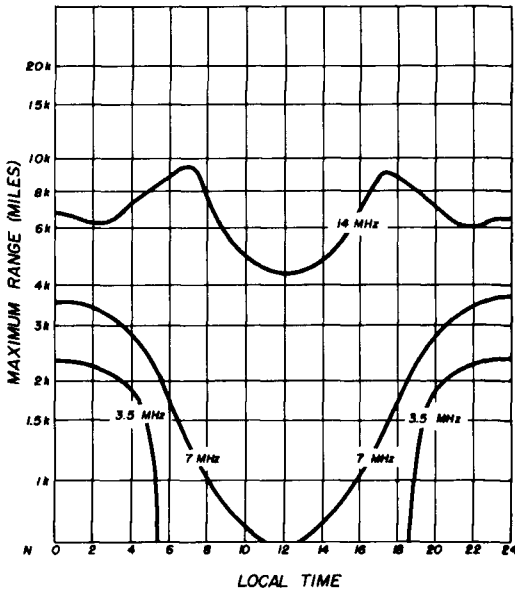

fig. 2. Maximum range to the north from 38° N latitude due to absorption.

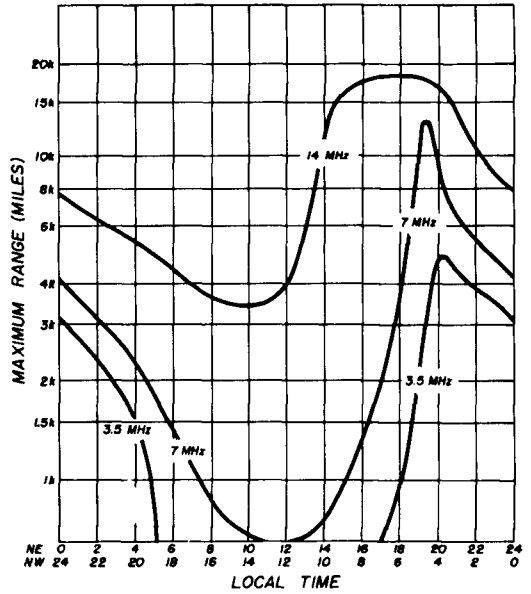

fig. 3. Maximum range to the northeast (top time scale) and to the northwest (bottom time scale) from 38° N latitude due to absorption.

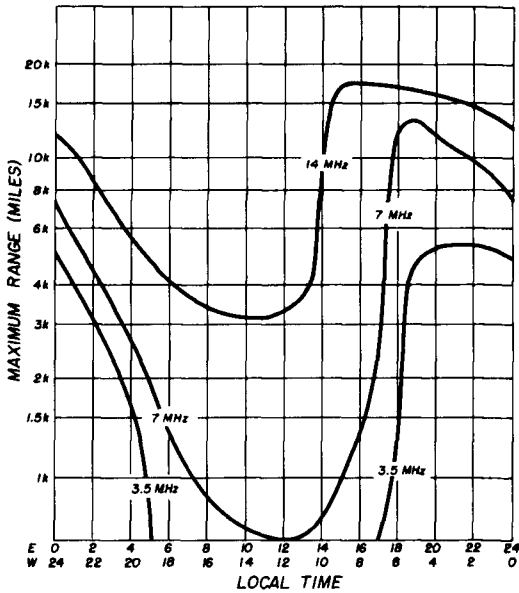

fig. 4. Maximum range to the east (top time scale) and to the west (bottom time scale) from 38° N latitude due to absorption.

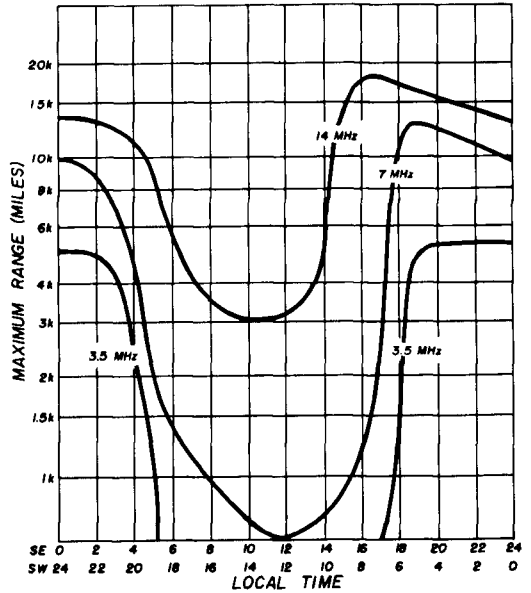

fig. 5. Maximum range to the southeast (top time scale) and to the southwest (lower time scale) from 38° N latitude due to absorption.

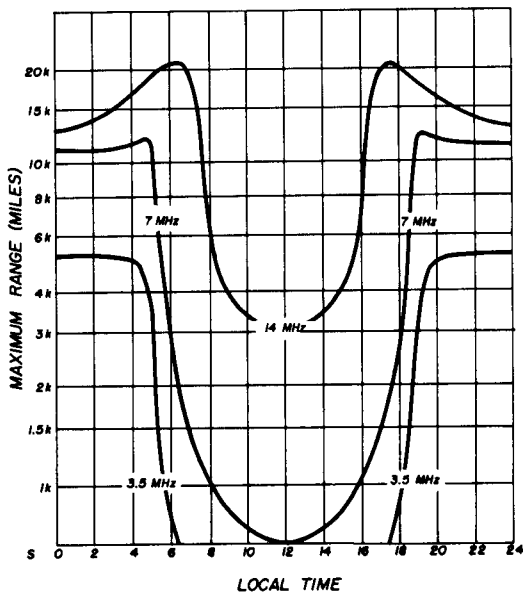

fig. 6. Maximum range to the south from 38° N latitude due to absorption.

you use. For example, a 10-dB increase in transmitter power or antenna gain above the

values given in the box on page 84 will increase the opening time to any particular range by about one hour.

sporadic-E propagation in July

Past performance has shown that July is one of the best months for multiple-hop sporadic-E propagation. How far have you worked using this mode? Few 50-MHz stations have worked further than three hops or 3700 miles. However, this is probably due to the lack of activity in the proper places rather than a lack of propagation. When the Pacific Ionospheric Scatter network was in operation a few years ago, signals near 50 MHz from Wake Island were often heard on the West Coast, 4350 miles away. Perhaps more important, an ionospheric sounder operating over a 6200-mile (10,000-km) east-west path lying below 50° N latitude observed 5- or 6-hop sporadic-C propagation at frequencies in excess of 20 MHz nearly 60% of the days of July 1966; on 28% of the days of July 1966, sporadic-E propagation was observed on frequencies greater than 30 MHz over the same path. This is plotted in fig. 7 with time of day at the path midpoint.

fig. 7. Percentage occurrence of multiple-hop sporadic-E propagation at frequencies greater than 30 MHz over a 6200-mile (10,000-kilometer) east-west path in the northern hemisphere during July 1966.

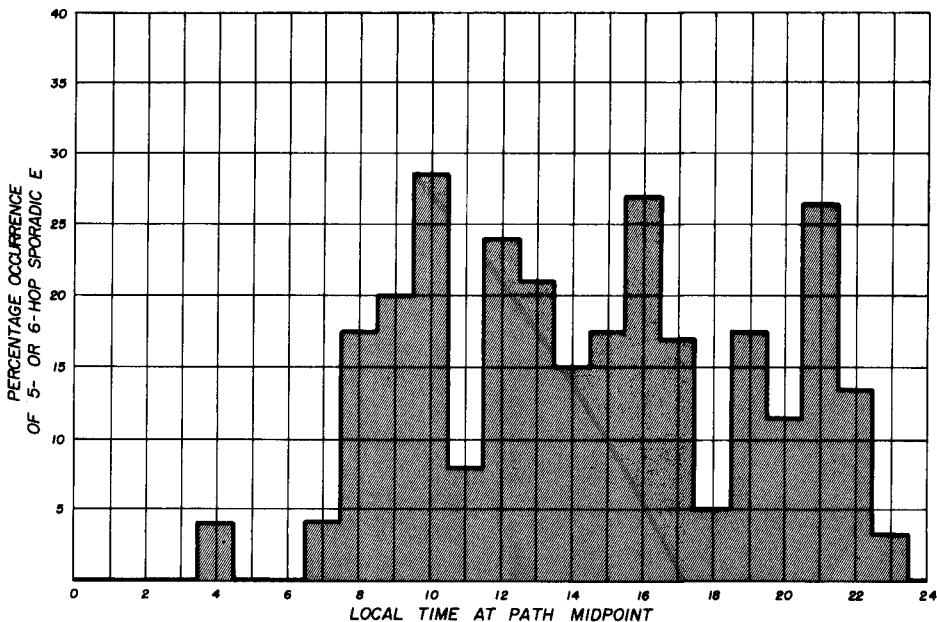

how to use these propagation charts

1. To find the maximum usable frequency (F2-4000 km) in any particular direction from your location, find the latitude of the control point from table 1. The control point will be 1200 miles (2000 kilometers) from your location.

The curves in fig. 1. show the MUF for the latitude and local time of the control point. Since the control point is 1200 miles away, local time there is 45 to 90 minutes later than your local time if it is to the east, and 45 to 90 minutes earlier if it's to the west. Unless your station is located in the middle of a local time zone, the standard time for your area is close enough for these calculations. Remember that standard time is the time at 75° W (EST), 90° W (CST), 105° W (MST) and 120° W (PST). For accurate time at your location, add four minutes per degree longitude west of the longitude which determines the time zone for your area.

Example: Your station is located at 34° N, you want to work east (90° beam heading) or west (270° beam heading). What would be the best operating times on 15 meters?

First, find the latitude of the control point from table 1—32° N. From the MUF curve, you can see that 21 MHz will be open for distances 2500 miles (4000 kilometers) and beyond between 0800 and 2200 hours control-point time. The band will be open to the east between 0630 and 0230 hours, and to the west between 0930 and 2330 hours local time.

2. To find the maximum propagation distance because of absorption, refer to fig. 2, 3, 4, 5 or

6, depending on the direction you want to work. Note that the time scales are reversed for westward propagation in fig. 3, 4 and 5. These curves are based on unity signal-to-noise ratio in a 6-kHz bandwidth with 100 watts output power (100 watts CW or 800 watts ssb), with combined receiver and transmitter antenna gains of -12 dB on 3.5 MHz, zero dB on 7 MHz, and +12 dB on 14 MHz. On ten and fifteen meters, the communications range should not be limited by absorption to less than one transit around the earth. However, anytime you expect minimum range on 14 MHz, round-the-world propagation will be minimal on 21 MHz.

3. To find the MUF for a particular path in the northern hemisphere, locate the other station's control point. Remember that it is 1200 miles (2000 kilometers) toward you. The MUF curve may then be used to make a crude approximation of his control-point MUF. The path MUF is the lower of the two control-point MUF's—yours and his. These curves are not useful for the southern hemisphere.

The MUF curves should be accurate within a couple MHz between 45° and 135° west longitude. They were prepared from basic propagation predictions published monthly by the Institute for Telecommunications Sciences (ITS), Boulder Colorado and available through the U. S. Government Printing Office. The maximum distance curves were derived from standard formulas at 1000-mile intervals in each of 8 directions from 38° N latitude.

One fact worth noting is that the amplitude of multi-hop sporadic-E modes was always lower than that of the multi-hop F2-layer modes, when present on the same frequency. In many cases, the difference was more than 20 dB.

table 1. Control-point latitudes (degrees N).

your latitude (degrees N)	direction				
	N	NE/NW	E/W	SE/SW	S
24	42	36	23	10	6
26	44	38	25	13	8
28	46	40	27	15	10
30	48	42	28	17	12
32	50	44	30	19	14
34	52	45	32	20	16
36	54	47	34	22	18
38	56	49	36	24	20
40	58	51	38	26	22
42	60	53	40	28	24
44	62	55	41	30	26
46	64	57	43	32	28
48	66	58	45	34	30

propagation summary for July

Below 30 MHz. High noise levels and absorption will continue to limit propagation on **40** and **80** to darkness paths. Don't expect any propagation over the North Pole on these bands because it is in continuous daylight. **Twenty** meters will continue to be a nighttime band for the DX'er. Look for openings on **10** and **15** during the day, particularly toward the south; short-skip sporadic-E propagation will be prevalent.

6 meters. Six should open up to distances between 1000 and 1500 miles more than one-third of the days of the month. Look for multiple-hop sporadic-E openings over paths greater than 3500 miles—if necessary, make schedules. Past experience has shown that the openings are there if you're around to take advantage of them.

ham radio

BOOKS

FOR YOUR AMATEUR RADIO LIBRARY



Radio Society of Great Britain Publications

AMATEUR RADIO CIRCUITS BOOK

Completely revised - new addition just now available. A very handy collection of many useful circuits for amateur use. Loaded with good ideas for that new converter, exciter or other project you are working on. **Only \$2.00**

RADIO DATA REFERENCE BOOK — Second Edition — By G. K. Jessop G6JP

Here in a 148 page book is one of the most complete compilations of radio and electronic charts, nomographs, formulas and design data available. Sections are included which permit you to design everything from rf power amplifiers to TVI filters. Also included is much related information such as world-wide frequency allocations and commonly used mathematical tables. Whether you design, build or operate, this is a book you should have. **Only \$2.50**

WORLD AT THEIR FINGER TIPS — John Clarricoats G6CL

A very interesting history of the RSGB and of amateur radio in Great Britain. It gives a great insight into the development of our hobby in England and Europe and the effects these events have had on amateurs here in the United States.

Paper back edition **\$2.50**

Deluxe edition **\$6.50**

HANDBOOKS BY RADIO PUBLICATIONS, INC.

BEAM ANTENNA HANDBOOK by William Orr, W6SAI

New edition. Theory, design, construction, and the installation of rotary beam antennas! SWR data! Multiband beams, 40 meter beams, 20 meter DX beams! How to make your beam work! 200 pages. **\$3.95**

VHF HANDBOOK by Orr, W6SAI and Johnson, W6QKI

First complete Handbook covering the VHF spectrum! Many VHF construction projects! Design and construction of VHF transmitters, receivers and antennas! Make your VHF station work! **\$3.75**

ELECTRONIC CONSTRUCTION HANDBOOK by Robert Lewis, W8MQU

All about design - construction - layout and testing of electronic equipment. Non-technical guide for kit-builders and your best key to better performance of your equipment! **\$2.95**

ALL ABOUT CUBICAL QUAD ANTENNAS by W6SAI

Construction and tuning data. Multiband Quads. Charts, drawings and photos for your Quad. Full complete data on home-made Quad antennas. The new X-Q Quad. **\$3.95**

NOVICE & TECHNICIAN HANDBOOK by W6SAI and W6TNS

All about amateur radio in nontechnical language! How to learn the code. How to assemble your ham station. Transmitters! Receivers! DX! How to Get QSL cards. **\$2.95**

BETTER SHORTWAVE RECEPTION, by Wm. Orr, W6SAI

Your introduction to shortwave radio. How to hear DX. How to buy a receiver. Amateur radio. How to align your receiver. Antennas! QSLs. Getting your ham license. **\$3.25**

S-9 SIGNALS by William Orr, W6SAI

Inexpensive DX antennas for your station! Multiband ground plane, \$5 beam antenna, 2 and 6 meter beams, Demi-Quad beam, and others! **\$1.00**

ALL PRICES POSTPAID IN U. S. A. AND CANADA

ORDER TODAY FROM

book division

comtec

Box 592

Amherst, New Hampshire 03031

new products

rotatable log periodic array



Are you interested in a really big antenna? If you are, try this new design from Granger Associates on for size. This antenna is 110 feet long and has a total width of 100 feet. It has sixteen active radiators and produces a gain of 12 dB and a front to back ratio of 15 dB. The frequency range is from 5.5 to 32 MHz with SWR of 2:1 maximum. Designed for the military market, this antenna has a power capacity of 20 kW average, 40 kW PEP, and will withstand up to 160 mile-per-hour winds with no ice.

The Granger Associates model 1730-3 Rotatable Log Periodic Antenna is complete with rotator, tower, balun, local-and remote-control units and complete assembly and erection instructions. Shipping weight is 9,000 pounds. For more information, write to Granger Associates, 1601 California Avenue, Palo Alto, California 94304.

Triplet solid-state vom



Triplet has just introduced a new battery-operated solid-state volt-ohm-milliammeter using FET's to provide 11 megohms input impedance on all ac and dc voltage ranges. In addition to the high input impedance, the FET circuitry provides improved stability over battery life and temperature changes.

The Triplet model 601 features 52 range selections, accuracy of $\pm 2\%$ full scale on dc and $\pm 3\%$ on ac, and a low-power ohms circuit for IC measurements. With the low-power ohms scale, 75 millivolts is applied to the device under test, and the maximum power applied is 0.1 milliwatt. The ac frequency response of the model 601 is 50 Hz to 50 kHz.

A 100-dB scale range is incorporated into this new vom for high fidelity and stereo servicing. Using the single selector switch, the user can make measurements from -40 to $+60$ dB. The dc full-scale ranges go from 0.1 to 1000 volts; the ac scales, 0.01 to 1000 volts; ohms from 1 to 1 megohm, both conventional and low power; and ac/dc current ranges from 10 microamperes to 10 milliamperes. The range selector also includes a battery-condition check position.

Battery life in normal usage is about one year. Although the model 601 is furnished with a complement of ten AA penlight cells, the instrument is designed so that it can use alkali, mercury, or nickel-cadmium batteries of the AA type.

The model 601 has a brushed aluminum

front panel and etched black range markings. The charcoal-grey case is constructed of high-impact material. A color-coded meter dial provides fast and easy readings. A slotted thumb screw on the back cover provides easy access to the batteries.

Because of the instrument's high sensitivity on ac measurements, the 601 uses a small, pencil-thin shielded probe. Price is \$125 complete with batteries, test probes and operating instructions. Check your local distributor, or write to the Triplett Electrical Instrument Company, Bluffton, Ohio.

Lafayette 7-band receiver

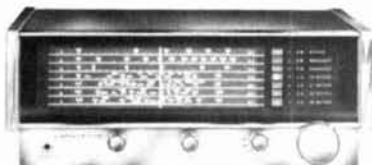

Lafayette Electronics Corporation has just introduced a new seven-band fm-am, short-wave and weather/marine receiver. This new receiver features individually-tuned circuits for each band, avc, a mechanical filter, tuned rf stage and transformer-operated power supply. The seven bands cover 150-400 kHz, standard a-m and fm broadcast bands, plus the short-wave bands from 5.9-6.25, 9.45-9.85, 11.85-12.05, and 15.05-15.55 MHz.

The illuminated slide-rule dial on this receiver is labeled with the names of primary cities and countries. The rear panel has terminals for a-m and fm antennas, tape recorder output, extension speaker and 24-volt dc input. FM sensitivity is 2 microvolts or less; cross modulation, 70 dB; distortion, 1% or better at 20 microvolts; image ratio, 45 dB; and antenna impedance, 300 ohms. Sensitivity on the short-wave bands is as low as 2 microvolts. Priced at \$99.95 from Lafayette Radio Electronics Corporation, 111 Jericho Turnpike, Syosset, Long Island, New York 11791. Order stock number 99-2601WX.



**Radio Amateurs
Reference Library
of Maps and Atlas**

WORLD PREFIX MAP — Full color, 40" x 28", shows prefixes on each country . . . DX zones, time zones, cities, cross referenced tables postpaid **\$1.00**

RADIO AMATEURS GREAT CIRCLE CHART OF THE WORLD — from the center of the United States! Full color, 30" x 25", listing Great Circle bearings in degrees for six major U.S. cities: Boston, Washington, D.C., Miami, Seattle, San Francisco & Los Angeles. postpaid **\$1.00**

RADIO AMATEURS MAP OF NORTH AMERICA! Full color, 30" x 25" — includes Central America and the Caribbean to the equator, showing call areas, zone boundaries, prefixes and time zones, FCC frequency chart, plus informative information on each of the 50 United States and other Countries. postpaid **\$1.00**

WORLD ATLAS — Only atlas compiled for radio amateurs. Packed with world-wide information — includes 11 maps, in 4 colors with zone boundaries and country prefixes on each map. Also includes a polar projection map of the world plus a map of the Antarctica — a complete set of maps of the world. 20 pages, size 8 3/4" x 12" postpaid **\$2.00**

Complete reference library of maps — set of 4 as listed above postpaid **\$3.00**

See your favorite dealer or order direct.

**WRITE FOR
FREE
BROCHURE!**

RADIO AMATEUR
callbook INC
Dept. O 4844 W. Fullerton Ave.
Chicago, Ill. 60639

NOW!!! STOCKED IN U. S. A.

JOYSTICK

VARIABLE FREQUENCY ANTENNAS

Send for Brochure

SHORTWAVE GUIDE

218-H GIFFORD ST., SYRACUSE, N. Y. 13202



NOW

**RAZOR SHARP CW
RECEPTION WITH
YOUR TRANSCEIVER!**

WITH A *Main* CWF-1
Between Your Headphones
And Your Rig

REQUEST BROCHURE \$19.95
Money Back
Guarantee

- ★ No Power Required
- ★ Plugs Into Phone Jack
- ★ Low Insertion Loss
- ★ 120 Cycles Narrow
- ★ 2 to 4 Ohms In. 2K Out



Dept. H-6
353 Pattie
Wichita, Kans. 67211
(316) 267-3581



KEEP UP TO
DATE ON
YOUR DXING

A weekly magazine (16 to 24 pages each week).

Current DX that's on the air, and info about what's planned for the immediate future. What's being heard by the boys. Etc.

FULL DX INFO EVERY WEEK.

Per year—Surface mail (they say most 1st class mail actually goes via air) \$11.00

The DXERS Magazine, (W4BPD)
Route 1, Box 161-A,
Cordova, S.C. 29039

radio amateur callbook



GET YOUR NEW ISSUE NOW!

Over 283,000 QTHs
in the U.S. edition
\$6.95

Over 135,000 QTHs
in the DX edition
\$4.95

See your favorite dealer or order direct (add 25¢ for mailing in U.S., Possessions & Canada. Elsewhere add 50¢).

These valuable EXTRA features included in both editions!

- QSL Managers Around the World!
- Census of Radio Amateurs throughout the world!
- Radio Amateurs' License Class!
- World Prefix Map!
- International Radio Amateur Prefixes
- Radio Amateurs' Prefixes by Countries!
- A.R.R.L. Phonetic Alphabet!
- Where To Buy!
- Great Circle Bearings!
- International Postal Information!
- Plus much more!

**WRITE FOR
FREE
BROCHURE!**

RADIO AMATEUR
callbook INC
Dept. 4844 W. Fullerton Ave.
Chicago, Ill. 60639

hi-fi stereo preamp ic

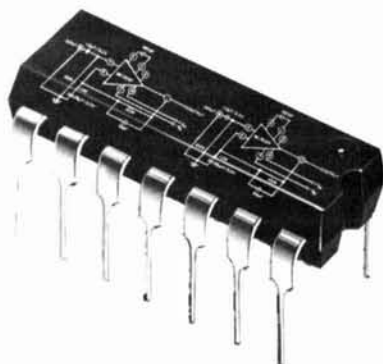

Motorola has just introduced a new integrated circuit which is specifically designed for high-fidelity amplification of low-level stereo signals. The MC1303P features a unique short-circuit-proof design which protects the device against accidental shorting in test or installation. The dual-channel preamp provides channel separation of 60 dB minimum at 10 kHz with less than 0.1% total harmonic distortion at the minimum rated output voltage swing of 4.5 volts rms.

The MC1303P data sheet presents application information including recommended equalizing networks that will provide flat frequency response in accordance with RIAA and NAB specifications. In addition, the data sheet has curves which show the noise and output loading characteristics of the device. The input bias current of the MC1303P is 1 μ A; input offset current, 0.2 μ A; input offset voltage, 1.5 mV; and dc power dissipation, 300 mW maximum. For more information, write to Motorola Semiconductor Products, Inc., Box 13408, Phoenix, Arizona 85002.

electronic circuit design handbook

How many times have you needed an electronic circuit to do a special job? A circuit you need right now and don't have time to design? If you have, this is a book you ought to have in your library—a compendium of more than 500 proven and tested circuits for all types of functions.

The circuits in this book were originally published in **EEE—the magazine of Circuit Design Engineering**. They were selected on the basis of their originality and practical application. This volume includes both simple and complex circuitry, as well as a lot of practical design data. If you have an application that isn't covered, usually you can find a circuit that can be adapted to suit your needs—they can also serve as stepping stones to almost any kind of circuit desired.

The circuit descriptions are supplemented by over 600 easy-to-follow schematics, diagrams, waveforms and illustrations. The tried and tested circuits constitute a vital source of ideas and techniques, and serve as "imagination triggers" for anyone who has an interest in circuit design and construction. \$14.95 from TAB Books, Blue Ridge Summit, Pennsylvania 17214.

headlight warning indicator

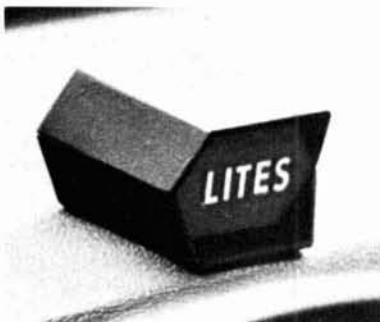

Although this may seem like a strange item to find in an amateur radio magazine, I wonder how many of you have gone away and left your car with your headlights or parking lights on. This little indicator flashes when your lights are on and your ignition is off—no more dead batteries! It features simple two-wire installation, solid-state circuitry, negative or positive ground and universal mounting. For all models and makes of cars, trucks and boats. Available for either 6 or 12-volt systems. \$2.98 postpaid from Mike Gauthier, K6ICS, Gauthier Industries, P. O. Box 216, Lynwood, California 90262.

LET W3KT FORWARD YOUR DX QSLs

Join the thousands of satisfied hams who have been using this service for the past seven years. During 1967 alone, over 200,000 QSLs were forwarded to DX stations. This is a DELUXE service, insuring prompt and continuous mailings, and involving a minimum of effort on your part.

Just fill in your QSLs and send them to W3KT. You don't have to address the cards, or indicate the QSL manager, or send any SASEs. Where a DX station uses a stateside QSL manager, your card will be sent to him with an SASE, and the reply will come back to W3KT, who will send it to your call area QSL bureau. Other QSLs will be sent to the proper QSL Bureau, or, if necessary, direct.

Remember, your QSL is a personal message. Therefore W3KT sends it by FIRST CLASS MAIL only.

7he charge: Four cents per QSL, 30 cards per dollar. **NO MEMBERSHIP FEE.**

SAVE TIME! SAVE MONEY!

W3KT QSL SERVICE

RD 1, Valley Hill Road Malvern, Penna. 19355

3ACP11A MEDIUM SHORT PERSISTANCE
FLAT FACED CRT LATE MANUFACTURE
FAIRCHILD-DUMONT NEW BOXED
LIMITED QUANTITY. \$4.95 ppd

LARGE SELSYNS TYPE 7G 115 VOLT
60 CYCLE SIZE ABOUT 6" DIA. x 8"
LONG. CHECKED. \$14.95 PER PAIR.
ALLOW SHIPPING FOR 50# PER PAIR.

DELCO 2N443 TRANSISTORS REMOVED
FROM NEW EQUIPMENT. ALL ARE CURVE
TRACED AND GUARANTEED. LIMITED
QUANTITY. 2 FOR \$1.65 ppd.

400 VOLT PIV @ 250 AMP DIODES.
TESTED AND FULLY GUARANTEED.
\$12.00 PER PAIR OR 4 FOR \$21.00 ppd.

50 VOLT PIV @ 150 AMP DIODES.
TESTED AND FULLY GUARANTEED. \$1.50
EA OR 4 FOR \$5.00 ppd.

M. WEINSCHENKER K3DPJ

PO BOX 353
IRWIN, PA. 15642

POLICE • FIRE • MARINE
AIRCRAFT • AMATEUR CALLS
ALL NEW 1968

X LINE TUNAVERTERS!

CRYSTAL & TUNABLE = VERSATILITY
USABILITY



Turn your auto and home radios into excellent VHF receivers

- Sensitive
- Selective
- Calibrated

A flip of the switch for either variable tuning or crystal controlled operation.

THE BEST—CALIBRATED 6-1 TUNING—
—DRIFT FREE CRYSTAL CONTROL—
PLUS —COMPLETE INTERCHANGEABLE
CRYSTALS WITHIN BAND!!!!

- 9 volt btry powered.
- 1 year guarantee on parts & labor.
- Includes coax, mount & screws.
- Size —2 1/2 x 3 1/2 x 4 1/4 inches.
- New FET transistor oscillator & circuit.
- American Made with American Parts.

Models for AM & FM		Tunable & Crystal!		
BAND	MODEL	COVERS	OUTPUT	PRICE
CB & 10 M	273 X	26.9-30 mc	1500 kc	
6 meters	504 X	50-54 mc	1500 kc	
2 meters	1450 X	144-150 mc	1500 kc	\$32.95 ppd.
Police, fire, Marine	348 X	33-48 mc	1500 kc	Each
Marine	1564 X	150-164 mc	1500 kc	
Aircraft	1828 X	118-128 mc	1500 kc	Less Crystal

Models for AM & FM		Tunable only		
BAND	MODEL	COVERS	OUTPUT	PRICE
Marine		2.0-2.85 mc	550 kc	\$19.95 ppd.
SW & WWV	SWL	10-20 mc	1500 kc	\$19.95 ppd.

Coupling Loop & Ext. Antenna for use with home and Transistor Radios.....\$3.95 ppd.
Mobile Battery Eliminator, 12V to 9V.....\$4.95 ppd.
Crystals—State Exact Listening Freq.....\$5.10 ppd.

Order from: Fast AIR MAIL add \$.85 ea.

HERBERT SALCH & CO. Marketing Division
Woodsboro H, Texas 78393 of Tompkins
Radio Products

CQ de W2KUW BEST OFFER!!

Paid..... for any piece of aircraft or ground radio units, also test equipment. All types of tubes. Particularly looking for 4-250 • 4-400 • 833A • 304TL • 4CX1000A • 4CX5000A et al. 17L • 51X • 390A • ARM • GRM • GRC • UPM • URM • USM units.
TED DAMES CO., 310 Hickory St., Arlington, N.J. 07032

SURPLUS WANTED

EQUIPMENT WITH PREFIXES ARA, ARC, ARM, ARN, APA, ASN, ASA, APN, APR, ARR, ASQ, GRR, GRC, GRM, GPM, VRC, UPX, URA, URR, URM, USM, UPM, SG, MD, PRM, PSM, PRC, TMQ, TRM, TED, SPA, SRT, CU. COMMERCIAL EQUIPMENT BY ARC, BIRD, BOONTON, BENDIX, COLLINS, MEASUREMENTS, H-P, NARDA, GR, SPERRY, ETC.

TOP CASH DOLLAR PAID OR TRADE

WE STOCK NEW HAM GEAR

WRITE - WIRE - PHONE (813) 722-1843
BILL SLEP, W4FHY

SLEP ELECTRONICS  **CO.**
2412 HIGHWAY 301 N. ELLENTON, FLORIDA 33532
PHONE (813) 722-1843

amphenol connectors



A new line of blister-packaged rf, audio and power connectors for amateurs and experimenters has been announced by Amphenol. The new packs, presently available at electronic parts distributors, include many hard-to-find connectors needed by project builders and electronics experimenters.

The new line of connectors is the result of two years of intensive in-the-field market research. Interviews with hundreds of buyers plus surveys of sales to experimenters resulted in a line that includes the broadest possible range of hobbyist needs. In addition to microphone and power connectors, the new line includes type-uhf coax connectors, straight, angle and tee adapters, push-on connectors and even in-line lightning arrestors.

Complete assembly information is printed on the reverse side of each blister pack. Detailed step-by-step instructions explain how the component should be assembled and used. Additionally, handy workbench reference booklets are available on each display. These booklets contain soldering information, schematic symbols, and resistor color codes as well as a complete catalog of Amphenol blister-pack components. Look for the new display at your distributor, or write to the Amphenol Distributor Division, 2875 South 25th Avenue, Broadview, Illinois 60153.

64.95 FOB

ATTENTION! ALL QUAD USERS!

64.95 FOB

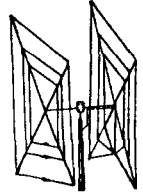
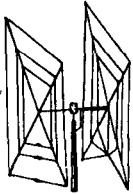

A NEW FIRST IN QUAD SPREADERS NEW TYPE QUAD SPREADER THAT BREAKS THE PRICE BARRIER.

W2AU now brings you a new W2AU Super 2el. tri-band 10-15-20 meter quad using the all new EXCLUSIVE heavy duty vinyl jacketed spreader.

This new spreader is made of selected bamboo entirely encased in a heavy duty vinyl covering, making it salt spray proof and completely weather resistant. No varnishing or treating necessary. Dark brown in color for resistance to ultra violet sun rays.

W2AU Super 2el. tri-band, 10-15-20 meter quad with vinyl coated spreaders. Introductory price **\$64.95** complete quad.

W2AU Fiberglass model 2el. tri-band 10-15-20 meter quad **\$99.95** complete quad.

W2AU QUAD ACCESSORIES NOW AVAILABLE TO HOME-BREWERS

Set of 8 Vinyl Jacketed spreaders, 12'6" long (sets only)	\$21.50 set
W2AU quad spiders to fit 2" boom, heavy cast aluminum	\$6.95 ea.
Set of 8 Fiberglass spreaders 12'6" long (sets only)	\$54.95 set
Boom to motor-driven mast mount plate, complete with all hardware	\$5.95

ALL PRICES FOB UNADILLA, N. Y.

UNADILLA RADIATION PRODUCTS, UNADILLA, NEW YORK

Manufacturer of W2AU Baluns and Quads. See page 93 this issue.

Motorola power amplifier/ switching circuits library

Motorola has just come out with a new technical reference tool aimed at the electronics designer who needs practical, comprehensive information about silicon power transistors in switching and amplifier designs. This book has 65 circuits that are devoted to saving the engineer time in design. It is highlighted by easy-to-understand, how-to-do-it topics like direct coupling to eliminate amplifier transformers, outguessing the effects of secondary breakdown transients, square wave forms, pulses, an exhaustive examination of ac-to-dc converters, FET's and high-voltage silicon power in entertainment and communications equipment and designing short-circuit-proof voltage regulators, just to name a few. This volume also includes a silicon power transistor selection guide which covers over 100 plastic and metal types of transistors spanning collector currents from 100 milliamps to 30 amps, collector-emitter voltages to 400 volts, power-dissipation ratings to 200 watts of f_{T_B} up to 60 MHz. Copies are available by writing on your company letterhead to Motorola Semiconductor Inc., Box 955, Phoenix, Arizona 85001.

The Electronic Invasion

Robert M. Brown, K2ZSQ, has authored a new book on electronic bugging and debugging that should be of interest to every amateur. This noted electronics expert, amateur, author, vhf'er and licensed private investigator reveals the secret techniques, devices, circuits, users and suppliers of bugs and anti-bugs in this new book. Bob takes you behind the scenes in electronic snooping and tells you how the experts do it. He shows you the circuits they use, and some of the gambits they follow when duping the poor victim. He covers telephone bugs, eavesdropping microphones, miniature audio amplifiers, fm wireless microphones, bumper beepers, recording spies, bug detection, speech scramblers and lots of bugging and de-bugging circuits.

If you're interested in buying bugging equipment, this book provides a directory of manufacturers and dealers and tells you a little bit about the legal aspects of electronic bugging. Must reading if you're interested in finding out what is going on in electronic snooping today. \$3.95 at your local electronic distributors or write directly to The Hayden Book Company, Inc., 116 West 14th Street, New York, New York 10011.

GET ACQUAINTED OFFER
 We would like to have your name on our mailing list for our fantastic 68 page pictured catalog of surplus Optical — Electronic bargains. To entice readers of HR to order from us we are offering some of our best values, and with an additional 10% discount (good until January 1, 1969) to boot. An order from you will automatically place your name on our mailing list, or send 25¢. (Don't delay quantities limited.)

RECEIVER SHELL. Antique telephone receiver shell - black plastic in perfect condition. Perfect encasement for walkie talkie miniature radio - almost anything! Alone, used as paperweight, also as float for those nautical bent. Anyway you have it a fun thing. Makes neat Salt & Pepper Shakers . . . ATR 4 for \$1.25 P.P.



P. C. BOARD, 8" x 5". This Board is bussed horizontally on one side & vertically on the other. To get any desired circuit by simply soldering components between the two grids. Excellent for bread-boarding circuits - all this plus a bonus of diodes, and other parts. PCB3 3 for \$1.25 P.P.

TELETYPE SPECIAL — GOV'T SURPLUS

101 New packaged spare parts for models 14, 15 and 19 teletypes. Over 40 different items include cans, balls, reels, covers, springs, type, key caps, etc. Government cost over \$900.00. The first part used will cover the cost of the kit, and you will have the added advantage of being back in operation immediately. This is one of our most popular items. Price: \$5.90 plus postage (include \$1.00 east of Miss., \$2.00 west).

TRANSFORMERS: These are all rugged military units rated for continuous duty. On intermittent or commercial service the current ratings may easily be increased 40% (we have operated the 18 amp filament transformer continuously at 30 amps with no discernible temperature rise. Allow for postage.

No.	Primary	Secondary	Price
T1	115, 120, 126, 123 volts 60 Hz Single Phase	6.6 volts @ 1.2 amps center tapped	\$1.75
T2	"	6.6 volts @ 1.2A, c.t.s.	\$2.50
T3	"	6.6 V @ 5 amp, 6.6 V @ 1 amp, c.t.	\$3.00
T4	"	6.6 V @ 10 amps, c.t.	\$3.00
T5	"	6.6 V @ 10 amps, c.t., 6.6 V @ 1.0 amps c.t.	\$3.50
T6	"	6.6 V @ 18 amps, c.t.	\$4.75
T7	115 V, 60 Hz	44, 22 or 11 V c.t. @ 2.0 amps	\$4.00
T8	Audio, 20-20 Hz, 7000 Ω c.t.	265 Ω c.t. or 80 Ω c.t.	\$3.75
T9	Audio 500-10 Hz 15,000 Ω 4 ma.	95,000 Ω split 11 dbm	50c
L1	Choke .05 to 0.25 Henry	@ 0.8 amperes d.c.	\$1.50
L2	Choke 0.5 to 0.25 Henry	@ 0.2 to 0.6 amps d.c.	\$2.50
T10	208 V, 3 phase, 60 Hz	275, 290 V @ 0.25 amps	\$2.50
T11	"	460, 490 V @ 0.25 amps	\$5.00
T12	"	202, 212 V @ 0.25 amps	\$2.50
T13	"	103, 109 V @ 0.408 amps	\$3.00
T14	"	180, 195 V @ 0.49 amps	\$3.50
T15	"	280, 325 V @ 0.75 amps	\$4.50
T16	"	24, 27 V @ 11.4 amps	\$4.75



Would you believe a Digital Voltmeter for \$15.00? Would you believe \$25.00?

We supply a large 6 digit numeral precision counter, a In429 precision reference zener diode, a 10 turn 0.25% linearity potentiometer, and a D. C. motor. For \$15.00. You must beg, buy, borrow or steal a \$10.00 operational amplifier (Analog Devices Nexus or equivalent) and your ready to roll. Schematic included list price of components we supply is over \$175.00. Digital Voltmeter Kit DVM \$15.00



TRANSISTOR TONE OSCILLATOR

Do not confuse this well-made military unit with low price commercial "ice cube packs." This unit operates from 1.5 to 6.0 volts, and has transformer isolated output. Frequency is 1000 Hz, may be varied with external pot. New package, and complete with spare set of transistors.

Applications: Continuity, component, and semiconductor tester, code practice oscillator, keying monitors, alarms, RTTY SHIFT Oscillators, etc. TTC \$2.00 P.P.

B & F ENTERPRISES

GOV'T SURPLUS • ELECTRONIC • OPTICAL • HOROLOGICAL • MECHANICAL

P. O. BOX 44, HATHORNE, MASS. 01937

FM

formerly FM BULLETIN

THE national FM'ers' journal

A monthly Ham Magazine for the Amateur
 who is interested in . . .

- SIMPLEX FM
- REMOTE OPERATION
- SIGNALING & TONES
- CONTROL TECHNIQUES
- CONSTRUCTION
- DECODING
- FREQUENCY LISTINGS
- MOBILE FM
- MOBILE RELAYS
- AUTOMATIC PHONES
- DESIGN DATA
- REPEATER INFO
- TRENDS
- OPERATION
- NEWS & VIEWS
- HUMOR
- SATIRE
- CLUBS
- ACTIVITIES
- DIRECTORIES
- EVENTS

\$3.00 per year or 2 years for \$5.00

SAMPLE COPY 35¢

FM MAGAZINE • 2005 HOLLYWOOD AVE., GROSSE POINTE, MICHIGAN 48236

GET IT from GOODHEART!

EVERYTHING UNCONDITIONALLY GUARANTEED

SILIC. RECTIF. 8000 PIV 400 MA. Large user's termin. invent., not rejects! Slater SLA08-2. Max: reverse, 2 uA; fwd drop, 8.2 v. Cost \$8 ea. **PAIR \$5.30**
Bakel. encapsul. 3"x1/2"x1/2" ht oa. **Postpaid \$5.30**

Brand New VHF rcvrs look like BC-453 Command but are 9-tube 108-135 mc. 2 uv sens., 2 rf's, 3 IF's; noise lmtr; avc. W/schem., instruct., spline knob, & graph to set freq. by counting turns. **A.R.C. Type 13B, \$22.50**
28v htr wiring; 7# shpg. wt. **\$27.50**
R32 is same but w/squeich; 14v htr wiring

R-23/ARC-5 Command rcvr 190-550 kc. 14.95
A.R.C. 12 #22 Command rcvr 540-1600 kc. 17.95
LM-14 freq. meter, .01% 125 kc-20 mc. 57.50
TS-323/UR freq. meter 20-480 mc. .001% 169.50
BC-221's OK \$57.50 TS-175 OK 125.00
CLOSING OUT Radio Receivers 38-4000 mc at CRAZY LOW PRICES! Ask for APR-4Y/CV-253 sheet.

ALL-BRAND SSB RCVR BARGAIN: Hallicrafters R-45/ARR-7., 550kc to 43 mc continuous. Voice, CW, MCW, aligned, grtd, w/book; 2-RF, 2-IF's, S-meter; noise lmtr: 3 xtl, 9 non-xtl selectivity choices. Less pwr sply. **149.50**

60cy pwr sply: \$30. SSB instructions free.
SP-600-JL Rcvr. 0.54-54 mc, aligned, grtd. 250.00
R-392/URR grtd OK, w/AC sply & book. 525.00

WANTED: GOOD LAB TEST EQUIP & MIL COMMUNIC.

TIME PAY PLAN: Any purchase totaling \$160.00 or more, down payment only. **10%**

WE PROBABLY HAVE THE LARGEST & BEST INVENTORY OF GOOD LAB TEST EQUIPMENT IN THE COUNTRY, BUT PLEASE, DO NOT ASK FOR CATALOG! ASK FOR SPECIFIC ITEMS OR KINDS OF ITEMS YOU NEED! WE ALSO BUY! WHAT DO YOU HAVE?

R. E. GOODHEART CO. INC.

Box 1220 HR, Beverly Hills, Calif. 90213
Tel: Area 213, office 272 5707, messages 275 5342

SURPLUS EQUIPMENT WANTED TO BUY BY THE FASTEST GUN IN THE EAST



No horsing around, we pay fast . . . in 24 hours . . . and we pay more. We'll swap or trade new equipment too . . . We quote fast. You also pay for shipping, insurance, etc. You call fast, now, collect, for fast quote.

SPACE ELECTRONICS

div. of MILITARY ELECTRONICS CORP.

4178 Park Avenue, Bronx, New York 10457, (212) CY 9-0300

WE PAY CASH FOR TUBES

LEWISPAUL ELECTRONICS INC.
303 W. Crescent Avenue
Allendale, New Jersey 07401

NOVICE CRYSTALS

Fundamental frequencies in FT-243 holders. Pin size .093 in., spacing .486 in. Tolerance .03% measured in oscillator with 82 mmfd. capacity.

80 meters 3705-3745 kc.	\$1.75 ea.
40 meters 7155-7195 kc.	1.25 ea.
15 meters 7034-7082 kc.	1.25 ea.
2 meters 8058-8186 kc.	1.25 ea.

Add for postage and handling per crystal: 8c first class; 12c airmail. Specify frequency desired and nearest available will be sent. Other frequencies in stock. Send for free list. Satisfaction guaranteed.

NAT STINETTE, P.O. Drawer Q-1, Umatilla, Fla. 32784

W2AU BALUN LETS ENTIRE ANTENNA RADIATE!

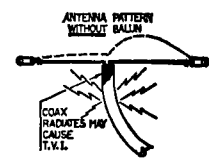
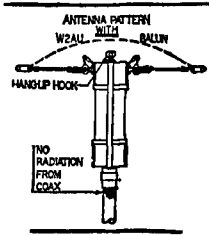

STOP WASTING YOUR SIGNAL! REMEMBER, YOUR ANTENNA IS THE MOST IMPORTANT PIECE OF GEAR YOU OWN.

- No Radiation from Coax
- No Center Insulator Needed
- Perfect for Inverted Vees (Use Hang-up Hook)
- Built-in Lightning arrester
- Broad-Band 3 to 40 Mc.
- Takes Legal Power Limit
- Two Models:
 - 1: 1 50 ohm coax to 50 ohm balanced
 - 4: 1 75 ohm coax to 300 ohm balanced
- A must for Inverted Vees, Doublets, Quads, Yagis and Multiple Dipoles.

\$12.95 AMATEUR NET

W2AU Complete pretuned Fiberglas Quad\$99.95
W2AU Complete pretuned Vinyl Quad\$64.95

UNADILLA RADIATION PRODUCTS
Unadilla, New York 13849

TELL YOUR FRIENDS ABOUT . . . **ham radio**

REVIEWED IN MARCH, 1968 HAM RADIO

oscillator/monitor

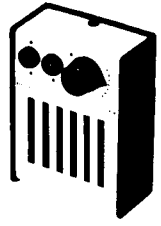

- a sensitive broadband RF detector gives audible tone signal in the presence of any RF field from 10mw to 1 kw and 100kc to 1000mc
- a CW monitor with positive "RF" switch uses only 8" pickup antenna and NO connection to rig or key
- a code practice oscillator with adjustable tone & built in speaker
- high gain 4 transistor circuit powered by long life AA pencil
- 16 gauge aluminum cabinet in white & black epoxy finish, 3 1/2" by 2 3/4" by 1 1/4", weight 8 ounces
- 100% US made and guaranteed

1295 (base incl) ppd usa & can send cert ck or m.o. ny res add 5% tax

the James research company
11 schermerhorn st., brooklyn n.y. 11201

★ ★ ★ ★ ★ BARGAINS ★ ★ ★ ★ ★

- 1.000 MHz Marker Xtals. For P.C. Boards, NEW \$1.50
- BC-603 110 Volt Power Supplies. Fits into dynamotor compartment of set. Limited quantities. \$7.95
- 6 & 12 V SOLID STATE Vibrator Eliminator. Fits 95% Transceivers. 25 Watt, 4 Pin Plug. Housed in Aluminum Heat Sink. 4 Pin Plug. W/Instr. \$2.80
- 100 Ua. DeJur Panel Meters. 1 1/2" diam. metal case. Special Photo-lite scale. Bk. Face. \$1.00 F.O.B. N.Y.C.

FREE!!! Spec. Chart of 20 IBM Transistors
Send for FREE CATALOG listing 100's of Relays, Components, Computer Boards, etc. ALL Electronic Tubes at great savings!

CORTLANDT ELECTRONICS, INC.

30 CORTLANDT STREET
NEW YORK, N. Y. 10008
(Inside Hudson Terminal Concourse)

★ ★ ★ ★ ★

DIODES

EVERY DIODE WE SELL IS CURVE TRACED ON A SPECIAL TESTER. THIS TESTER DRIVES 2 AMPS AVERAGE CURRENT THROUGH THE UNIT IN THE FORWARD DIRECTION WHILE THE REVERSE LEAKAGE IS MEASURED (.25 MICROAMPS). THE OPERATOR EXAMINES THE CURRENT-VOLTAGE PLOT OF EACH DIODE ON AN OSCILLOSCOPE SCREEN. WE FULLY GUARANTEE EVERY UNIT SOLD OR YOUR MONEY REFUNDED.

PIV	TOP-HAT 1.5 AMP	EPOXY 1.5 AMP	EPOXY 3 AMP	STUD-MOUNT 6 AMP
50	.04	.06	.12	.15
100	.06	.08	.16	.20
200	.08	.10	.20	.25
400	.12	.14	.28	.50
600	.14	.16	.32	.58
800	.17	.20	.40	.85
1000	.20	.24	.48	.75

ZENERS

ALL UNITS TESTED AND GUARANTEED
ALL 1 WATT

5 1/2 3 for \$1.00		10 1/2 4 for \$1.00	
11	12	13	15
16	18	20	22
24	27	30	33
36	39	43	47
51	56	62	
68	75	82	91
100	110	120	130
150	160	180	200

VOLTS

3 YEARS OF SERVICE
TO THE AMATEUR FRATERNITY
HAMS SERVING HAMS

PLACE YOUR ORDER WITH ONE OF THE FOLLOWING HAMS

M. Weinschenker K3DPJ
PO Box 353
Irwin, Pa. 15642

Pete Fragale W8AEN
PO Box 585
Clarksburg, W. Va. 26301

PA Residents Please Add 8% PA Sales Tax Minimum Order \$3.00. All Orders Ppd in USA

ANTENNA SPACE YOUR PROBLEM?

TRY THE BARBED WIRE ANTENNA

A low-cost, easy-to-assemble application of the Fat Antenna Theory.

ADVANTAGES INCLUDE

- *1/8—Wavelength Shorter than a Conventional Half-Wave Dipole.
- *Greater Bandwidth—Less SWR Problems.
- *Easier to Match and Load.

THE BARBS IN KITS \$16.50 Prepaid.

\$2 Brings Construction Details & Picture.

Send for Free Brochure.

CTK Enterprises—WB6ZKK
Box 444
Montebello, Calif., 90640

HAMS! DON'T BUY USED TUBES — COMPARE THE FOLLOWING PRICES. ON ITEMS NOT SHOWN WE WILL BE VERY HAPPY TO QUOTE.

6J6	.45	0B2	.60	807	1.95	404A	2.25
6T8	.75	2X2	.50	6146	2.50	1AX2	.39
6U8	.72	10Y	.50	6360	3.00	25L6	2.48
0A3	.80	7025	.55	12AU7	.52	2E26	2.50
0C3	.60	6AQ5	.55	2021	.45	811A	3.75
0D3	.60	68Q7	.88	6AS6	.65	8226	12.95
0A2	.70	6C87	.54	417A	2.25	4-65A	10.00
4-125A	25.00	UX200A	1.50	4-4000A	37.50	4PR60B	55.00
4X150A	12.50	4-250A	35.50	4-1000A	80.00	4CX250B	21.00
80	1.15	10Y	.59	1625 (same as 807-12V)	.95		

Silicon Repl. For 0Z4, 5U4, 5Y3, 5AS4 5Z4, 98.
Kit of 50 tested Germanium Diodes, 1N34A, etc., \$1.00;
8 Top Hat 450 Piv. 500 MA, \$1.00.

10 Sil. Epox. Diodes-400-750-Piv-1 Amp., \$1.00
4 Power (20W) Transistors, \$1.00; WE 701A-1000W Tetrode, \$5.95.

10 Flangeless Rectifiers, 1 amp. 400 to 1000 Piv., \$2.75.
10 Silicon Epox. Diodes 400 to 750 Piv. 1 amp., \$1.00
5 Transistor circuit boards containing up to 6 transistors, plus diodes, resistors, capacitors, etc., .89.

Sale on brand new CH & H & H Toggle Switches — never used — Removed from new equipment:

SPST 6 amp. . . \$1.50 dz. SPDT 6 amp. . . \$1.69 dz.
DPST 6 amp. . . 1.69 dz. DPDT 6 amp. . . 1.85 dz.
DPDT 15 amp. . . 2.95 dz. SPST Slide SW., 8/\$1.00

AC DC Elec. Cond. 50X30 MFD at 150 V, 25; 3X15 MFD at 450 V, .49; 1625 Beam Power Amplifier, .95; 841 Power Triode for 6-30MC., .50; 6.3V Fil. Transf. PRI 115V AC 60 Cy, Sec. 6.3V at 1.5A Open Type, .39; 25 ft. 2-3 Wire #14 Rubber Shielded Cable, \$1.25; 12 Spkr. Plug, \$1.00; 6 Audio Output Trans., \$1.75; Asst. 1W Resistors, \$1.00; 40 Asst. 2W Resistors, \$1.60; Precision Resistors, \$1.00; 6 1/2 Meg. Vol. Controls, \$1.00; 25 Asst. Pilot Lights, \$1.00; 60 Asst. TV Pkng. Coils, \$1.00; 12 Asst. Dual Controls, \$1.00; 12 Spkr. Cords w/Plug \$1.00; 12 Asst. RF Coils-SW, \$1.00; 100 Asst. AB-IR 1/2-1.2W Res., \$1.00; 50 Asst. Mica Cond., \$1.00; 12 Vol. Controls, \$1.00; 25 Asst. Trimmer Cond., \$1.00; 50 Asst. Paper Tubular Cond., \$1.00; 12 Asst. Elec. Cond. Kit, \$1.00; 20 Asst. Wire Wound 5-25W, \$1.00; Universal Tape Recording Motor H.D. 1500 RPM, \$3.95; Dual Speed Recording Motor 2000 & 3000 RPM, \$3.50; Universal Tuner CH 2-13, 41 MC VHF Tuner, fit any TV with 68Q7 & 6X8, \$2.95; FM Tuner Can Be Hooked Up, Super-Het with tube and dial, \$2.67.

Canadians Must Remit in U.S. Funds. No C.O.D. Orders. The above is only a sample of over 5,000 bargains we have. Min. order 5.00 not including postage (extra). Send for bargain tube and parts catalog.

UNITED RADIO COMPANY
56 FERRY ST., NEWARK, N. J. 07105
Established 1920

CORRECTION

In our ad on page 93 in the MAY issue of HAM RADIO the price for the 4-125A is \$25.00

Send Stamp for bargain tube and parts catalog
UNITED RADIO CO.
56 Ferry St., Newark, N. J. 07105

TRANSISTORIZED CONVERTER KITS

Converts car radio to receive police and fire calls

TWO MODELS

30-50 mc or 100-200 mc (1 mc tuning)

With perforated board \$5 — With printed circuit \$7.50

Instructions included

Crystal controlled — Crystal \$2.50

MESHNA

21 Allerton Street, Lynn, Mass. 01904

**MOCHTEN SIE WISSEN WAS DIE VHF-
UND UHF- AMATEURTECHNIK IN
EUROPA LEISTET?**

Lesen Sie die UKW-BERICHTE, die autoritative Viertel-Jahres Veröffentlichung in Deutscher Sprache. Jedes Heft enthält sechzig Seiten mit praktischen Artikeln über VHF- und UHF-Radiotechnik, beigetragen von den führenden Amateuren Europas.



Zeitschrift für den VHF- und UHF-Amateur

**INTERESTED IN WHAT EUROPEAN
HAMS ARE ACCOMPLISHING AT THE
HIGHER FREQUENCIES?**

Read UKW-BERICHTE, the authoritative German quarterly, now with English summaries! Applications of the latest VHF and UHF techniques; equipment and antenna construction details. Each sixty-page issue packed with practical articles written by the most outstanding amateurs in Europe.

**Annual subscription U.S.A. \$3.00,
Canada \$3.25**

**H. Ingwersen, PA0AFN Box 87, Topsfield,
Mass. 01983**

HIGHEST \$ \$ PAID FOR TUBES



120 WEST 18th STREET

NEW YORK 10011 • 212-242-7400

Free Tube List

ATV'ERS

For the largest US ATV magazine;
Technical reports & ATV directory
SEND \$2 for a 1 year subscription
TO:

A5 MAGAZINE

150 Delong Ave.,
Dumont, NJ 07628

**THE GREAT NEW
GALAXY V
MARK 3**



**5 Band
SSB Transceiver
only \$420**

**BARGAINS IN RECONDITIONED
USED GEAR**

JOHNSON INVADER 2000	\$525.00
GALAXY III	\$225.00
DRAKE R4A, T4X, AC Pwr Supply Immaculate with all manuals	\$600.00
WARRIOR LINEAR (UEW572B's)	\$180.00

Write for list of used gear at bargain prices; we give you the best trade-in allowance for your gear on NEW, GALAXY, SWAN, DRAKE and ALL LEADING LINES of amateur equipment. Write today for quotation:

Bob's **AMATEUR**
ELECTRONICS

K5EZG - BOB

"THE COMPLETE HAM STORE"

Phone CE 5-6387

927 N.W. 1st Oklahoma City, Oklahoma 73106

ETCHED CIRCUIT BOARDS

Novice Trans.	2.75	Novice Recvr.	2.75
RTTY Encoder	2.50	RTTY Decoder	4.00
UHF Dippers	2.25	SWR Bridge	1.25
Lab Supply	3.50	144 Conv.	5.75
Keyer	4.95	CP Osc. Mon.	1.25

Conn. Residents add Sales Tax.
Send order or Catalog request to . . .

**HARRIS CO., BOX 985,
TORRINGTON, CONN. 06790**

TECH MANUALS

R-390A/URR, OS-8C/U, URM-25, URM-26B, \$5.50 ea; TS-587B/U, URT-7, TT-41B, KY-58/GRT, TED, \$6.50 ea; CV-116/URR, LM-18, TS-186D/UP, R-274/FRR, ARC-27, \$4.50 ea; Military SP-600JX \$5.00; TV-3A/U, ME-25A/U, BC-312/314/342, TS-505A/U, \$3.00 ea; VRC-19, FRR-3, \$3.50 ea. Prices postpaid USA. Payment with order please.

SAM CONSALVO, W3IHD

4905 ROANNE DRIVE, WASHINGTON, D.C. 20021

NOW

**EXCLUSIVE 66 FOOT MOR-GAIN 75 THRU 10 METER DIPOLE
NO TRAPS — NO COILS — NO STUBS — NO CAPACITORS**

Fully Air Tested — Thousands Already in Use

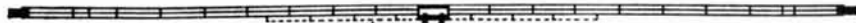

MULTIBAND SECTIONS

FULLY GUARANTEED

US PAT #3,229,298

40% Copper Clad wire—Under three lbs. Air Weight—Rated for full legal power—AM/CW or SSB—Coaxial or Balanced 50-75 ohm feed—VSWR under 1.5 to 1 at most heights—Rust resistant hardware—Drop-proof insulators. Completely assembled, ready to put up. Model 75/40 Amateur Net \$26.00. Terrific Performance—No coils or traps to break down or change under weather conditions—Fully Guaranteed. MODEL SB20 "SHORTY" 10 & 20 METER TRAP BEAM—\$59.95.

NEW SUPER HEAVY DUTY DIPOLES 66' LONG, RATED 4KW PEP-2000 POUND BREAKING STRENGTH—DELTRIN CENTER & CERAMIC END INSULATORS—OUT PERFORM FULL SIZE DIPOLES;
75/40 SHD \$33.00; 75-20 SHD \$38.00; 75-10 SHD \$48.00

MODEL 75-15 NOVICE	\$30.00	• 66 FEET LONG
MODEL 40/20	\$20.00	• 36 FEET LONG
MODEL 80/40CW	\$28.00	• 69 FEET LONG
MODEL 75-10	\$37.00	• 66 FEET LONG
MODEL 75-20	\$33.00	• 66 FEET LONG

ORDER DIRECT OR WRITE FOR
FULL INFORMATION

MOR-GAIN

P.O. Box 6006
Alexandria, Virginia 22306

OR THRU YOUR FAVORITE
DISTRIBUTOR

Phone: 703-768-7766; Nights and Holidays 703-780-2171

**NEW
BEAM**

*there's a reason for
the S/LINE's reputation
and*

**ELECTRONICS CENTER has
it in stock**

The main reason is performance. Amateurs around the world praise the S/Line's clean, strong signal. But there are design reasons, too. The S/Line is an engineered system. Each unit augments the others to provide single sideband operation at its best.

You can operate the system as a transceiver, or transmit with the 32S-3 and receive with the 75S-3B on separate frequencies. The S/Line offers upper and lower single sideband and CW operation . . . plus AM reception. Two linear amplifiers round out the full-performance S/Line.



Send for wife pacification kit . . . includes literature on both the console and the Collins equipment.

electronics center, inc.
2929 N. HASKELL 214-LA6-2023 DALLAS, TEXAS 75204

Advertisers iNdex

A-5 Magazine	95
Aerotron, Inc.	Back Cover
Autovolt, Inc.	53
B & F Enterprises	92
Bob's Amateur Electronics	95
CTK Enterprises	94
Ceco	95
Comdel, Inc.	79
Comtec, Book Division	72, 85
Consalvo, Sam	95
Cortland	93
Dames Co. Theodore E.	90
Drake Co., R.L.	2
DXER'S Magazine	88
Electronic Applications Co.	58
Electronics Center, Inc.	96
Evans Radio	62
FM Magazine	92
Goodheart Co. Inc., R.E.	93
Gordon Co., Herbert W.	Cover III
Hafstrom Technical Products	62
Ham Radio Magazine	47, 63, 94
Harris Co., The	95
Henry Radio Stores	19
International Electronic Systems, Inc.	43
James Research Co., The	72, 93
Lewispaull Electronics, Inc.	93
Main Electronics, Inc.	87
Meshna, John, Jr.	94
Military Electronics Corp.	93
Mission Ham Electronics	59
Mor-Gain	95
Mosley Electronics, Inc.	1
Quement Electronics	39, 47
Radio Amateur Callbook, Inc.	87, 88
Salch & Co., Herbert	90
Shortwave Guide	87
Slep Electronics Co.	90
Stellar Industries	73
Stinnette, Nat	93
Swan Electronics	27, 37
Tri-Ex Tower Corp.	Cover II
UKW Magazine	95
Unadilla Radiation Products	91, 93
United Radio Co.	94
Vanguard Labs	73
WIMU Hamfest	72
W3KT QSL Service	89
Weinschenker, M.	89, 94
Westcom Engineering Co.	58

Why the Reginair 321 Quad is Important to you!

Present day transceiver and transmitter designs require an antenna match with as flat a resonant response as possible. In the olden days a typical 500 watt rig required a relay rack and 500 pounds of gear. The physical spacing and voltage parameter of the tank circuits were such that one never worried about VSWR; indeed, that term had not yet been coined! Flash over and mismatch were laughed at and tolerated.

What a difference today! In a table top box scarcely 1½ cubic feet and weighing less than 50 pounds we find a modern side-band transmitter and receiver thrown in as well. Take a good look at the components: fixed capacitors smaller than ½ a postage stamp; a loading capacitor with .005 inch spacing; and transmitting tubes that are in reality TV horizontal outputs. These, then, are what you find. Do you wonder then why the manufacturer tells us we must operate into loads of 2.5 to 1 or better? Do you wonder then why the factory says to tune up in less than 30 seconds? Is it a surprise to you to find that new finals are required so quickly?

Look at this problem more closely. The 6HF5's are rated 30 watts dissipation. Two of them in parallel equal 60 watts limit. Yet the rig has a PEP rating of 500 watts and can develop up to 265 RMS watts in the forward or incident position. Its power supply furnishes 800 volts. You adjust the bias for 50 mills average, or 40 watts. Here is two-thirds of the total dissipation rating in idling power. The danger comes into the picture because the average ham can't or won't confine his operation over that narrow spectrum where his antenna is in resonance and where his VSWR is less than 2.5 to 1.

The pi - network output circuitry is only efficient with a SWR of 2 to 1 or less. Thus, when this SWR is exceeded, not only is your signal affected, but many components in your rig are endangered and reliability suffers.

Sure — new SSB designs are in the works: transceivers whose receivers will have variable selectivity; whose transmitters will use

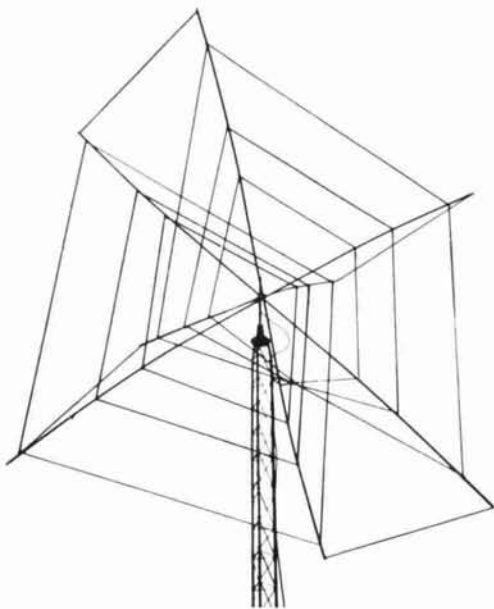

better tubes; rigs that can take more guff. But can you wait that long or afford that much money?

There is an alternative now — in fact, two choices. You can either be more mindful of the frequency tolerances of your setup, or better still, you can obtain one of our Reginair Quads. This is the only commercially available product that gives three band operation with one 52 ohm feed line and absolutely guaranteed low, low VSWR over the entire 10, 15, and 20 meter bands.

This Quad is furnished complete with easy to understand assembly instruction, at only \$89.95 FOB Harvard, Massachusetts. We prefer to ship via Railex. Study the box score and see if this antenna isn't the answer to your operating and maintenance problems. You might even find that DXing can be fun now that you are hearing the rare one.

BOX SCORE

VSWR over 28-29.7 MHz; not more than	1.5:1
VSWR over 21-21.45 MHz; not more than	1.5:1
VSWR over 14-14.35 MHz; not more than	1.5:1
Maximum RF input	2 kw
Maximum mast dimension	1 ¾" dia.
Wind resistance	4.5 sq. ft.
Feed line	52 ohms
Outside dimensions	18"x18"x12"
Turning radius	9 ½"
Net weight	35 pounds
Shipping weight	40 pounds
Designed for 100 mph winds; ½" radial ice	
Tubing — Poly vinyl chloride	
Spider Hud — Indestructible ABS	
Standard model price	\$89.95

HERBERT W. GORDON COMPANY

Harvard, Massachusetts 01451 • Telephone 617 — 456 — 3548

"Helping Hams to Help Themselves"

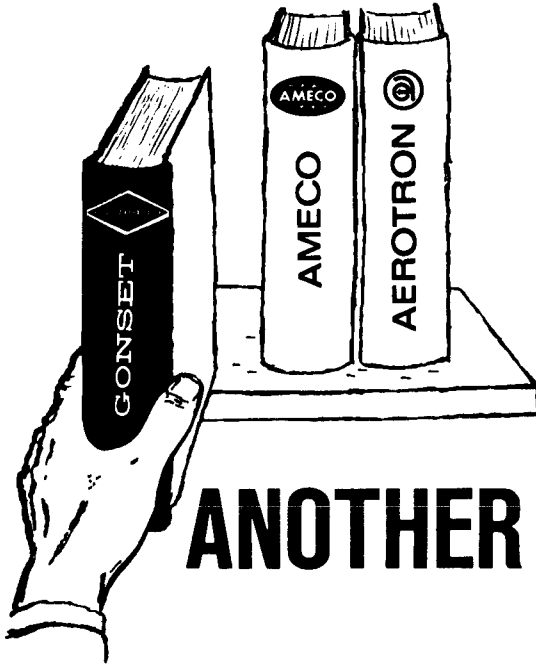

ANOTHER ADDITION

AEROTRON is proud to announce the acquisition of the famous Gonset line of quality amateur radio equipment. This acquisition appreciably broadens the line of equipment and components which we have to offer to the amateur and related markets. We are now shipping directly from our award-winning plant in Raleigh, the Gonset Communicators, Single Sideband VHF transceivers, HF and VHF linear amplifiers and other items bearing the Gonset name. In the coming months we will have even more.

AEROTRON, with more than twenty years in the two-way radio manufacturing business, has also acquired the AMECO Equipment Corporation during the past year. Ameco, formerly of Mineola, New York has been completely moved to our Raleigh plant and we are constantly adding to this popular line of economically priced equipment which is sold by more than a thousand radio supply outlets throughout the country.

The **GONSET** name has been a familiar and respected one by hams the world over for many years. It is with a great deal of pride that we now have it as a division of Aerotron, Inc.



AEROTRON

U. S. HIGHWAY 1, NORTH RALEIGH, NORTH CAROLINA 27608

MANUFACTURERS OF FM AND AM TWO-WAY RADIO, SSB AND ISB COMMUNICATIONS, CONTROLLER FUEL CONTROL AND DATA EQUIPMENT, AMECO HAM, CB AND SHORT WAVE LISTENING EQUIPMENT.